

# FEM-Design

## Applied Theory and Design

<b>FEM-Design .....</b>	<b>1</b>
<b>Info.....</b>	<b>5</b>
<b>1 Analysis calculations .....</b>	<b>7</b>
1.1 Finite element calculations .....	7
1.1.1 Basics.....	7
1.1.2 Static analysis.....	7
1.1.3 2 <sup>nd</sup> order analysis.....	8
1.1.4 Stability analysis .....	9
1.1.5 Linear dynamic .....	10
1.1.6 Seismic analysis .....	10
1.1.6.1 Introduction .....	10
Time history .....	11
Modal analysis .....	11
Lateral force method (Equivalent static load method) .....	12
1.1.6.2 Input data.....	14
1.1.6.2.2 Design spectrum.....	15
1.1.6.3 Calculation parameters and calculation steps.....	20
1.1.6.3.1 Calculation methods selection .....	20
1.1.6.3.2 Other setting possibilities.....	27
1.1.6.3.3 Combination rule, rotation and second order effects.....	28
1.1.6.3.4 Displacement calculation .....	31
1.1.6.4 The results of seismic calculation.....	31
1.1.6.5 Summation of static and seismic effects.....	32
1.1.6.5.1 Seismic loads in static load cases.....	32
1.1.6.5.2 Final results of seismic effect (Seismic max.) in load combination	33
1.1.6.5.3 Final results of seismic effect (Seismic max.) in load groups ....	34
1.1.6.6 Useful tips, which method to use?.....	34
1.1.7 Non-linear calculation.....	35
1.1.7.1 Uplift calculation .....	35
1.1.7.2 Crack analysis in FEM-Design Plate.....	35
1.1.8 Finite elements .....	38

1.1.8.1	2D plate .....	38
1.1.8.2	2D wall .....	39
1.1.8.3	2D beam .....	41
1.1.8.4	3D shell.....	42
1.1.8.5	3D beam .....	44
1.1.8.6	3D solid .....	46
1.1.8.7	Point support.....	50
1.1.8.8	Line support.....	50
1.1.9	Finite element mesh .....	52
1.1.9.1	Generate .....	52
1.1.9.2	Refine .....	50
1.1.9.3	Optimal rebuild .....	50
1.1.9.4	Smooth.....	51
1.1.10	Load group calculations .....	51
1.1.10.1	EuroCode (EC2) .....	51
1.1.10.1.1	Ultimate limit state .....	51
1.1.10.1.2	Serviceability limit state .....	52
<b>2</b>	<b>Design calculations .....</b>	<b>55</b>
2.1	Basics .....	55
2.2	Concrete Design .....	55
2.2.1	Design forces .....	55
2.2.2	Shrinkage as load action.....	57
2.2.3	Design calculations for surface structures .....	59
2.2.3.1	Ultimate limit state.....	59
2.2.3.2	Shear capacity .....	60
2.2.3.3	Punching.....	61
2.2.3.3.1	Checking .....	61
2.2.3.3.2	Design .....	61
2.2.3.4	Serviceability limit state.....	62
2.2.4	Design calculations for bar structures.....	67
2.2.4.1	Material properties Concrete .....	67
Steel	68	
2.2.4.2	Longitudinal reinforcement .....	68
Torsion	.....	70
ULS checking	.....	71
Space between bars	.....	73
Lengthening and anchorage	.....	74

2.2.4.3	Stirrups Shear .....	74
	Torsion .....	77
	Shear and torsion.....	78
2.3	Steel Design .....	79
2.3.1	General .....	79
2.3.2	Limitations .....	79
2.3.2.1	Torsion .....	79
2.3.2.2	Crushing of the web.....	79
2.3.3	Global analysis.....	79
2.3.3.1	General .....	79
2.3.3.1.1	Choose between a 1 <sup>th</sup> order or a 2 <sup>nd</sup> order analysis .....	80
2.3.3.2	Structural stability .....	81
2.3.3.2.1	1 <sup>th</sup> order theory.....	81
2.3.3.2.2	2 <sup>nd</sup> order theory.....	82
2.3.3.3	Imperfections for global analysis of frames.....	83
2.3.3.3.1	Conventional method.....	83
2.3.3.3.2	Alternative method .....	84
2.3.3.4	Division of members .....	86
2.3.4	EuroCode (EC3).....	86
2.3.4.1	Classification of cross-sections .....	86
2.3.4.2	Axial force capacity .....	88
2.3.4.2.1	Tension force .....	88
2.3.4.2.2	Compression force.....	88
2.3.4.3	Bending moment capacity.....	90
2.3.4.4	Shear capacity.....	90
	Shear area.....	91
	Web buckling .....	91
	Contribution from flange .....	93
2.3.4.5	Shear and Torsion.....	93
2.3.4.6	Warping torsion (Vlasov torsion).....	93
2.4	Timber Design .....	94
2.4.1	General.....	94
2.4.2	Global analysis.....	94
2.4.2.1	General.....	94
2.4.2.2	Structural stability .....	94
2.4.2.2.1	1 <sup>th</sup> order theory.....	94

2.4.2.2.2	2 <sup>nd</sup> order theory.....	95
2.4.2.3	Imperfections for global analysis of frames.....	96
2.4.2.3.1	Conventional method.....	96
2.4.3	Ultimate limit state.....	98
2.4.4	Load duration classes.....	98
2.4.5	Service classes.....	98
2.4.6	Materials and product properties.....	98
2.4.6.1	Load-duration and moisture influences on strength.....	98
2.4.6.2	Load-duration and moisture influences on deformations.....	99
2.4.7	Verification by the partial factor method.....	99
2.4.7.1	Design value of material property.....	99
2.4.8	Material properties.....	101
2.4.8.1	Solid Timber.....	101
2.4.8.1.1	Strength classes.....	101
2.4.8.2	Glued laminated timber.....	102
2.4.8.2.1	Strength classes.....	102
<b>3</b>	<b>Section Editor.....</b>	<b>105</b>
3.1	Basics.....	105
3.2	Calculation of the geometrical properties.....	106
3.2.1	Tension, bending.....	107
3.2.2	Elastic-plastic bending.....	108
3.2.3	Free torsion.....	108
3.2.4	Constrained torsion.....	109
3.2.5	Shear.....	109
3.2.6	Lateral buckling.....	111
3.2.7	Finite element method for sections.....	111
<b>4</b>	<b>Geotechnical module.....</b>	<b>113</b>
<b>5</b>	<b>References.....</b>	<b>113</b>

# Info



## Applied Theory and Design 12.0

Copyright: Structural Design Software in Europe AB

Date: 100315

For the latest information visit **FEM-Design** home page at

[www.FEM-Design.com](http://www.FEM-Design.com)



# 1 Analysis calculations

## 1.1 Finite element calculations

### 1.1.1 Basics

**FEM-Design** can perform the following calculations:

- linear static analysis for all structure types,
- static analysis according to second order theory for spatial structures, global stability analysis-buckling shapes and critical loads for spatial structures,
- dynamic analysis-vibration shapes and eigen frequencies for all structure types,
- seismic calculation-response spectra method for 3D models,
- non-linear static analysis-supports resisting only compression,
- cracking analysis-tracking of the cracking process.

### 1.1.2 Static analysis

The linear static analysis is the solution of the equation:

$$\mathbf{K} \mathbf{u} = \mathbf{Q}$$

linear, inhomogenous equation system with constant coefficients, which is derived from the displacement method,

where: **K** the coefficient matrix of the system, the so called stiffness matrix,

**Q** matrix of the load vectors, derived from the loads of every load cases,

**u** matrix of the displacement of nodes.

**FEM-Design** contains two equationsystem-solvers. One of them is the so called frontal type, the other is the **SKYLINE** type solver. Both methods are optimized for the available memory, and they contain very efficient node numbering optimization for minimizing of on one hand the front width, on the other hand the band width.

The results of the linear static analysis are always the node displacements, reaction forces and internal forces or stresses of elastic elements.

Note, that an average value is taken for the internal forces of elements in nodes of region or plate where more elements of the same kind are connected, in order to avoid discontinuities that does not exist in reality but generated by the finite element method during the calculation.

### 1.1.3 2<sup>nd</sup> order analysis

Calculation of structures based on the linear theory mean that the equilibrium conditions are determined according to the shape of the structure before loading. In case of larger deformations the results would be more accurate if the change of structure geometry was taken into consideration.

In case of flexible, elastic structures the approximate solution for this problem is the second order theory which gives satisfying accurate results for practice. In this theory the deformations during the loading are only taken into consideration in the relationship of membrane forces and bending moments. For example, at a straight bar the normal force influences the bending moments because of the deflections perpendicular to the bar, and it modifies of course the deflections. Consequently, the stiffness matrix of the system is a linear function of the normal internal forces (in case of plane plate, membrane forces):

$$[\mathbf{K} + \mathbf{K}_G(\mathbf{N})] \mathbf{u} = \mathbf{Q}$$

where  $\mathbf{K}$  is the original (linear) stiffness matrix,  $\mathbf{u}$  is the matrix of the node displacement,  $\mathbf{Q}$  is the matrix calculated from the loads, and  $\mathbf{K}_G$  is the geometrical stiffness matrix.  $\mathbf{N}$  in the argument means the distribution of the normal (or membrane) forces of the structure.



Since the stiffness is a function of the normal force distribution, the calculation has to be performed in two steps. First, the normal forces of the elements have to be calculated by using the  $\mathbf{K}$  matrix. In the second step  $\mathbf{K}_G$  can be determined according to the previously calculated  $\mathbf{N}$ , then the modified displacements, internal forces and stresses can be calculated by the  $[\mathbf{K} + \mathbf{K}_G]$  matrix.

It is possible, that the  $\mathbf{N}$  normal force distribution calculated from the loads happens to result in a singular  $[\mathbf{K} + \mathbf{K}_G]$  modified coefficient matrix, which means that the equation system can not be solved. This phenomenon occurs if the load is larger than the critical load of the system which makes it lose stability.

### 1.1.4 Stability analysis

At description of second order theory it was pointed out that the resultant stiffness of the system depends on the normal force distribution. In case of linear elastic structures the geometrical stiffness matrix is a linear function of normal forces and consequently of loads:

$$\mathbf{K}_G(\lambda \mathbf{N}) = \lambda \mathbf{K}_G(\mathbf{N})$$

The structure loses its loadbearing capability if the normal forces decrease the stiffness to zero, i.e. the resultant stiffness matrix becomes singular:

$$\det[\mathbf{K} + \lambda \mathbf{K}_G(\mathbf{N})] = 0$$

It is an eigenvalue calculation problem, and the smallest  $\lambda$  eigenvalue is the critical load parameter.

The calculation has to be performed in two steps. First, the normal forces of the elements has to be calculated by using the  $\mathbf{K}$  matrix. In the second step  $\mathbf{K}_G$  and the  $\lambda$  parameter can be determined. The critical load is the product of the load and the  $\lambda$  parameter. The above mentioned eigenvalue problem is solved by the so called Lanczos method in **FEM-Design**. The results of the calculations are as many buckling shapes as the user required and the matching  $\lambda$  critical load parameters.

## 1.1.5 Linear dynamic

If the loads acting on a structure vary quickly, the node displacements of the structure also vary as a function of time. In this case the outer loads-according to the d'Alambert theorem-should be extended by the distributed inertial forces which are proportional to the acceleration of the points of the structures. This results the following basic equation, if the dumping of the structure is ignored:

$$K u = Q - M u''$$

where:  $\mathbf{M}$  is the diagonal mass matrix of the structure and  $\mathbf{u}''$  is the matrix of the node acceleration (second derivative of the node displacements and rotations).

If the structure is unloaded, i.e. the free oscillation is analysed, all points of a structure with statically determined supports move periodically, according to the following equation:

$$u = A \sin(\omega t)$$

If  $Q = 0$ , it results in the following eigenvalue problem:

$$[K - \omega^2 M] A = 0$$

where:  $\omega$  is the eigen angular frequency and  $\mathbf{A}$  is the matching vibration shapes, or amplitude distribution. The eigenvalue problem is solved by the so called Lanczos method in the 3D and by the subspace iteration method in the 2D modules of **FEM-Design**.

## 1.1.6 Seismic analysis

### 1.1.6.1 Introduction

Seismic calculation is a special case of forced vibration calculation, when the exciting effect is the ground acceleration which is time dependent and of course not periodical. The response of the structure to the ground acceleration will be a vibration like motion. The structure gets forces of inertia which is calculated according to the Newton's law ( $F = m a$ ) and it is proportional to the mass and acceleration. These equivalent forces of course cause internal forces, stresses and if they are larger than the limit value the structure may collapse.

From the above explanation we found that originally this is a dynamic phenomenon when the acceleration and so the inertia forces change in each second. The interaction of the ground and structure is complicated so in a given time the acceleration of the structure depends on several components:

- ground acceleration (the seismic magnitude and its development on time),
- the elasticity of the structure,
- the mass and mass distribution of the structure,
- the connection between the structure and ground, namely soil type.

Another complicated problem is to define exact direction of the ground motion in the seismic investigation. Generally the ground movement is assumed as an arbitrary horizontal motion but the vertical motion also may cause problem to the structure.

Fundamentally the calculation process can be divided into three methods:

### **Time history**

This calculation is carried out as an ordinary forced vibration when the excitation is a time dependent acceleration function. These functions can be registered or simulated seismograms. Mathematically we always solve the differential equation system of the vibration by a suitable method (e.g. step-by-step method). From the results of the equation system (means the displacement of the structure) the internal forces can be calculated and the design can be performed.

Theoretically the method is exact, but several circumstances strongly constrain the usage:

- Statistically the number of seismograms are insufficient,
- The calculation is very complicated and the runtime is long.

Because of the above mentioned difficulties, this method is not widespread and is not implemented in **FEM-Design**.

### **Modal analysis**

As was mentioned in the above method, the vibrations arising from the seismic effect are difficult to predict. So the modal analysis assumption starts from the

investigation of the most unfavorable ground motion directions and the period time.

Expected value of the maximal accelerations belongs to the individual periods which are prescribed in the national codes and named as *acceleration response spectrum*. The horizontal axis shows the frequency or vibration time of a single degree mass-spring system and the vertical axis shows the maximum corresponding acceleration. (In the Civil Engineering practice vibration period is used instead of frequency.)

The results which belong to the different ground motion directions and structural eigenfrequencies are summarized on the basis of the probability theory, which assumes that not all the effects appear in the same time. Most frequently used summation rule is the **SRSS** (Square Root of Sum of Squares).

Although the modal analysis is the most accepted method all over the world (as well as in EC8), it has some disadvantages. Some of them are listed as follows:

- The results which are calculated using the **SRSS** summation rule are not simultaneous. For example for a bending moment in a point of the structure we can't show the simultaneous normal force in the same point, because the summation is carried out from component to component separately. Consequence of the summation rule, other calculations (second order application, stability analysis) are not interpreted,
- Mainly from the application of the statistical method, the graphical results weakly can be followed compare to the results of statical calculation,
- In a lot of cases greater number of vibration shapes should be calculated to reach a reasonable results which requires long calculation time.

Despite of all disadvantages of this method, we can expect most trustable results if the code requirements are fulfilled.

### **Lateral force method (Equivalent static load method)**

The lateral force method partly eliminates the disadvantages of the previous method with simplification in certain cases. The method postulates that the displacement response of the structure for ground motion can be described with one (or both  $x'$ ,  $y'$  directions) *mode shape*. While this means generally a simpli-

fication or approximation, this method is suitable for a part of the structure (EC8 prescribes the condition of application). In this method the *mode shape* of the structure is a linear deviation or it is equivalent to the calculated fundamental vibration shape. In the case of linear deviation or mode shape the period also can be calculated by approximate formula.

The application of this method gives possibility to transform the seismic lateral forces to simple static loads and it is applicable as follows:

- these loads (seismic load cases) can be combined with other static loads,
- second order and stability analysis can be performed,
- it is also possible to use these loads for hand calculation, so the results can be checked easily.

This method is usable in **FEM-Design** with two options if the code permits:

- assumption of linear deviation shape when the period also can be defined by the user (**Static, linear shape**),
- application of the calculated fundamental vibration shape as the deformed shape of the structure and its period (**Static, mode shape**).

#### **Remarks in application of national codes:**

- Before releasing the current version of **FEM-Design**, only the Eurocode and Norwegian national code contained special description for seismic calculation. In the other codes **FEM-Design** supports only the general modal analysis,
- Most of the countries did not prepare the National Application Document (NAD) for the universal Eurocode, so the program uses the general prescription,

- Supported national codes and methods:

British	Modal analysis
Code independent	Modal analysis
Danish	Modal analysis
Eurocode (NA:--)	EC8-2005 (No NAD, static method, modal analysis)
Eurocode (NA:British)	EC8-2005 (No NAD, static method, modal analysis)
Eurocode (NA:German)	EC8-2005 (No NAD, static method, modal analysis)
Eurocode (NA:Italian)	EC8-2005 (No NAD, static method, modal analysis)
Finnish (B4:2001)	Modal analysis
Finnish (By50:2005)	Modal analysis
German	Modal analysis
Hungarian	Modal analysis
Norwegian	NS3491-12 (static method, modal analysis)
Swedish	Modal analysis

- Norwegian code differs from Eurocode in a few places, so they are reviewed together and the differences are marked separately.

## 1.1.6.2 Input data

### 1.1.6.2.1 Dynamic Calculation (vibration shape and period) and Mass definition

To calculate the seismic effect it is necessary to know the vibration shapes and corresponding periods, except the static method (lateral force method: linear force distribution). Therefore a dynamic calculation should be done before performing seismic calculation, which gives *sufficient vibration shapes* of the structure. To perform the dynamic calculation, it is necessary to define mass distribution which can be defined in **Load** tab as concentrated mass or load case-mass conversion.



According to EC8 3.2.4(2), mass distribution should be made in the following way:

$$\Sigma G_{k,j} + \Sigma \psi_{E,i} Q_{k,i}$$

where:  $\psi_{E,i}$  is the combination coefficient for variable action **i** (see EC8 4.2.4), it shall be computed from the following expression:

$$\psi_{E,i} = \phi \psi_{2,i}$$

The recommended values for  $\phi$  are listed in EC8 Table 4.2.

The above formula means that mass conversion is made from all dead load without any factor, also masses in gravity direction temporary loads with reduced value.

### 1.1.6.2.2 Design spectrum



The program contains EC8 and NS3491-12 predefined design spectra or the user can define its own spectra if necessary. The vertical spectrum is necessary when the vertical affect taken into account.

#### EC8 design spectrum

The code gives the horizontal and vertical spectra and although the value of variables is prescribed, they can be modified if necessary.

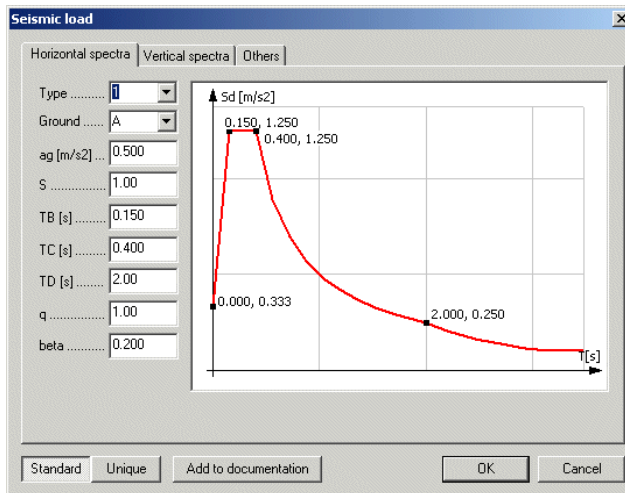

Data of horizontal design spectra:

**Type** type of spectra, which there are two in the code,  
Applied Theory and Design - Analysis calculations

**Ground** ground type, which can be **A, B, C, D** and **E**,

The above two data specify the values of **S**, **T<sub>B</sub>**, **T<sub>C</sub>** and **T<sub>D</sub>**, which can be found in EC8, table 3.2 and 3.3.

**a<sub>g</sub>** is the design ground acceleration on type A ground ( $a_g = \gamma_1 a_{gR}$ ),

**S** is the soil factor,

**q** is the behavior factor, which depends on material and type of the structure,

**beta** ( $\beta$ ) is the lower bound factor for the horizontal design spectrum.

The **S<sub>d</sub>(T)** horizontal design spectrum is based on EC8 3.2.2.5 as follow:

$$0 \leq T \leq T_B \quad S_d(T) = a_g S \left[ \frac{2}{3} + \frac{T}{T_B} \left( \frac{2.5}{q} - \frac{2}{3} \right) \right]$$

$$T_B \leq T \leq T_C \quad S_d(T) = a_g S \frac{2.5}{q}$$

$$T_C \leq T \leq T_D \quad S_d(T) = \left\{ \begin{array}{l} = a_g S \frac{2.5 T_C}{q T} \\ \geq \beta a_g \end{array} \right\}$$

$$T_D \leq T \quad S_d(T) = \left\{ \begin{array}{l} = a_g S \frac{2.5 T_C T_D}{q T^2} \\ \geq \beta a_g \end{array} \right\}$$

The built-in vertical design spectrum is derived from the horizontal spectrum using the **a<sub>vg</sub> / a<sub>g</sub>** multiplier which can be found in EC8 table 3.4 and described in 3.2.2.5(5)-(7).



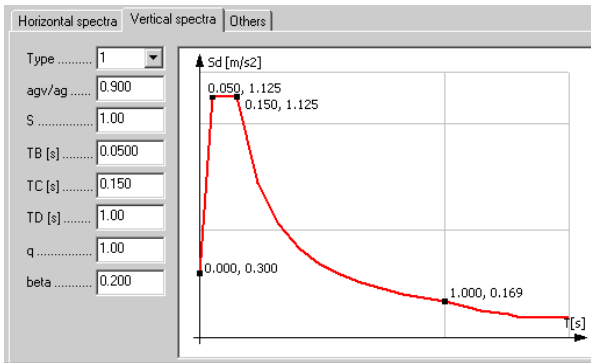

### Other input parameters (Others tab)

In the **Others** tab, the user should set some parameters that effect the calculation and results.

**Ksi**( $\xi$ ) is the viscous damping ratio, expressed as a percentage, generally 5%. This data is used in *modal analysis* when the summation of the effect of the same direction vibration shapes is carried out by the CQC (Complete Quadratic Combination), see later.

**qd** is the displacement behavior factor, assumed equal to **q** unless otherwise specified.

**Foundation level** when **Static-linear shape** is used, the program assumes that the foundation level is defined on that height. It means the program calculates the mass height from that level. In the other two calculation methods (**Static-mode shape** and **Modal analysis**) *base shear force* is drawn in that level and it is taken into consideration in the so called *reduced mass* calculation (details in **Effective mass setting**).

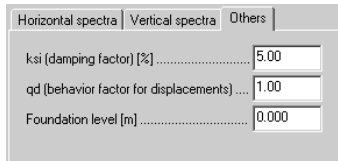

## Data of design spectrum about NS3491-12

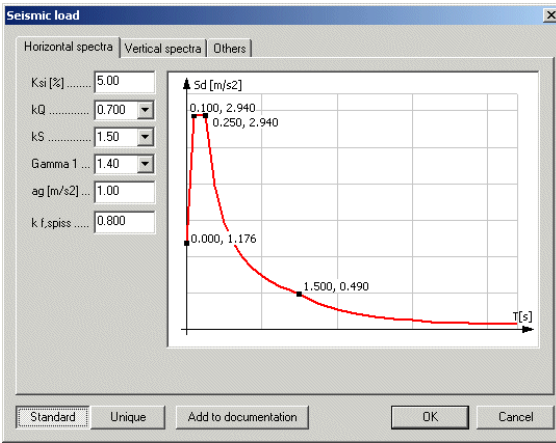

The built-in horizontal design spectrum is based on the following formula:

$$S_d(T_i) = k_Q k_S \gamma_1 a_g S_e(T_i) k_{f, spiss}$$

where: **Ksi**( $\xi$ ) is the declining ratio for the structure, given in %. Usually 5%,

**k<sub>Q</sub>** is a structure factor, dependent on the type of structure,

**k<sub>S</sub>** is a soil factor, dependent on the type of ground,

**Gamma 1**( $\gamma_1$ ) is a seismic factor, dependent on the seismic class,

**a<sub>g</sub>** is the maximum ground acceleration, dependent on location and reference period,

**S<sub>e</sub>(T<sub>i</sub>)** is the acceleration for the period **T<sub>i</sub>** in the normalized response spectra, see below,

**k<sub>f,spiss</sub>** is a factor dependent on the reference period used.

Vertical design spectrum formula:



$$S_{vd}(T_{v,i}) = k_v \gamma_1 a_g S_e(T_{v,i}) k_{f, spiss}$$

where **k<sub>v</sub>** is the ratio between horizontal and vertical response spectra, mostly set to 0,7.

The normalized response spectrum in Norwegian code is based on four different formulas, each covering a part of the possible periods from 0 to 4 seconds. Periods over 4 seconds has to be treated in a different way anyhow, and can therefore be based on a manually written response spectrum.

In **FEM-Design**, we assume, the spectrum is constant for periods over 4 seconds and equal to the value of  $S_d(T = 4)$ .

$$\begin{aligned}
 0 \leq T \leq T_B & \quad S_e(T) = 1 + \frac{T}{T_B} (2.5\eta - 1) \\
 T_B \leq T \leq T_C & \quad S_e(T) = 2.5\eta \\
 T_C \leq T \leq T_D & \quad S_d(T) = 2.5\eta \frac{T_C}{T} \\
 T_D \leq T \leq 4 & \quad S_d(T) = 2.5\eta \frac{T_C T_D}{T^2}
 \end{aligned}$$

where:  $T$  is the vibration period,  $T_B = 0,1\text{sec}$ ,  $T_C = 0,25\text{sec}$  and  $T_D = 1,5\text{sec}$   
 $\eta$  is a factor describing how the swaying declines, calculated as:  
 $\sqrt{10/(5 + \xi)} \geq 0,55$

### Other input parameters (Others tab)

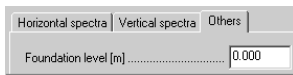

In the NS3491-12 code only foundation level should be set.

### Design spectra in the other national codes

Except for the above mentioned two codes, the user has in all cases to define the spectra in table or in a graphical way. In the **Others** tab only the foundation level should be set.

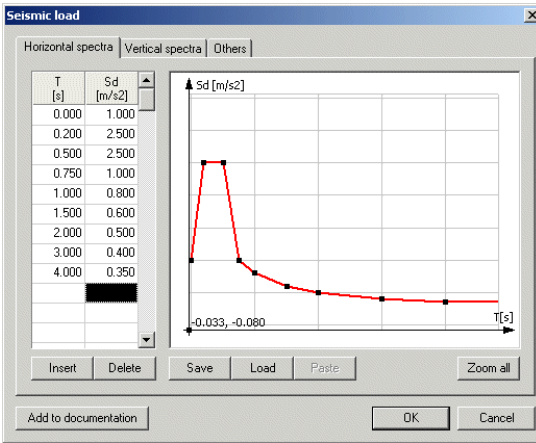

### 1.1.6.3 Calculation parameters and calculation steps

Calculation input parameters can be set in the **Calculation** dialog in **Analysis/Seismic** analysis in the **Setup** as can be seen below.

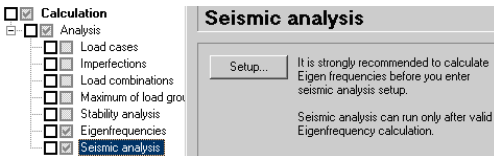

**Remark:** **Setup** for the **Seismic calculation** can be done at any time, but the Seismic calculation could be performed only after *Eigenfrequency* calculation.

#### 1.1.6.3.1 Calculation methods selection

National codes always provides which **Seismic calculation** method to be performed for different structure, where and when it should be performed and what other effects to be considered (torsional effect, P- $\Delta$  effect). As an example in Norwegian code NS3491-12, seismic calculation is not necessary if the acceleration from the design spectrum is  $S_d(T_1) \leq 0,5 \text{ m/s}^2$  where  $T_1$  is the base vibration period. In EC8 3.2.1 some criteria can be found.

**FEM-Design** provides three types of calculation methods in harmony with EC8 and NS3491-12.

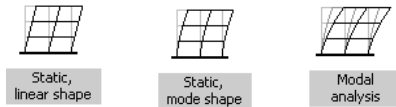

These three methods really cover two basic concepts:

- Lateral force method, where the *base shear force* can be distributed in two ways (**Static linear/mode shape**),
- Modal response spectrum analysis (**Modal analysis**).

### **Lateral force method (in some codes: equivalent static analysis)**

**EC8** as well NS3491-12 uses this method. The user may not use this method in other codes.

This method can be used to calculate the seismic effect in horizontal plan,  $\mathbf{x}'$  and/or  $\mathbf{y}'$  direction. The main point of this method is to calculate *base shear force* taking into account the base vibration period and design spectrum in  $\mathbf{x}'$  or  $\mathbf{y}'$  direction which is distributed into those nodes of the structure where there are nodal masses. The *base shear force* formula is taken from EC8 4.3.3.2.2(1)P:

$$F_b = S_d(T_1) m \lambda$$

where:  $S_d(\mathbf{T}_1)$  is the value of design spectrum at  $\mathbf{T}_1$  (means the acceleration of the structure),

$\mathbf{T}_1$  is the fundamental period of vibration of the building for lateral motion in the direction considered,

$\mathbf{m}$  is the total mass of the building, above the foundation or above the top of a rigid basement. **Remark:** the **FEM-Design** always takes into account the total mass of the structure including the basement,

$\lambda$  is the correction factor, the value of which is equal to: 0,85 if  $T_1 \leq 2 T_C$  and the building has more than two storeys, or  $\lambda = 1,0$  otherwise.

From this formula it can be seen that the *base shear force* is nothing else than the total seismic force of inertia (from second Newton's law) which acts between the ground and the structure.

Remarks for NS3491-12:

- There is no  $\lambda$  ( $\lambda = 1,0$ ).
- According to the code, if  $S_d(T_1) \leq 0,5 \text{ m/s}^2$ , seismic analysis can be suspended, so when the above condition is fulfilled, it is not necessary to incorporate seismic loads in the design.

Distribution of the *base shear force* can occur in two ways which is described below.

### **Linear distribution of horizontal seismic forces (Static, linear shape)**

In this method the distribution of *base shear force* happens according to a simplified fundamental mode shape which is approximated by horizontal displacements that increased linearly along the height (see EC8 4.3.3.2.3(3)). The seismic action effects shall be determined by applying to the  $\mathbf{x}'$  or  $\mathbf{y}'$  direction. The horizontal forces are:

$$F_i = F_b \frac{z_i m_i}{\sum z_j m_j}$$

where:  $F_b$  is the seismic *base shear force*,

$F_i$  is the horizontal force acting on the place of  $m_i$ ,

$z_i, z_j$  are the heights of the masses  $m_i, m_j$  above the foundation level.

According to NS3491-12 the distribution formula is:

$$F_i = F_b \frac{z_i^k m_i}{\sum z_j^k m_j}$$

where:  $k = 1$  for  $T_1 \leq 0,5 \text{ sec}$

$k = 2$  for  $T_1 \geq 2,5 \text{ sec}$

In the 0,5-2,5 interval the value of the  $k$  is interpolated linearly.

As a matter of fact eigenfrequency calculation is not necessary for this method, because giving the base period time in  $x'$  and  $y'$  direction is enough for the calculation. Practically, eigenfrequency calculation is performed before setting this data, but these data can be defined using experimental formulas as well. Investigation can be done in  $x'$  or  $y'$  direction, or both together.

The user may set the calculation direction to be performed by selecting the desired direction. To set the desired  $x'$ - $y'$  direction user should give the  $\alpha$  angle ( $\alpha$  is the angle between the global  $x$  and  $x'$ ).  $\alpha = 0,0$  means  $x'$ - $y'$  directions coincide with global  $x$ - $y$  directions. More details can be found in **Horizontal direction setting for seismic calculation** to set the correct seismic effect direction ( $\alpha$ ).

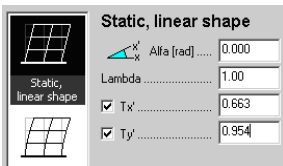

Some limitations of this method:

- Unusable if the whole foundation is not in the same plane,
- Unusable if the horizontal foundation is elastic.

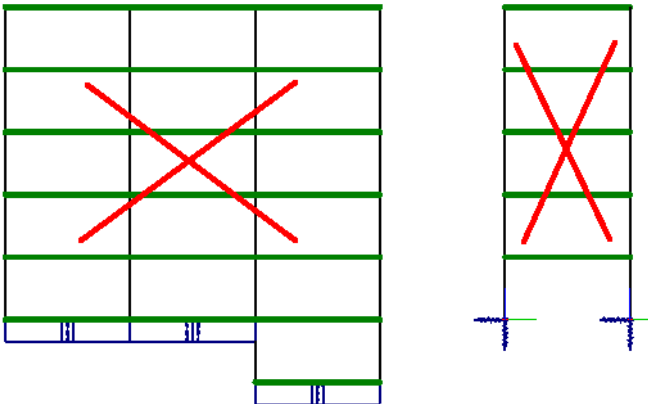

If any of the above mentioned situations happen, the *static, mode shape* or *modal analysis* should be used.

## Distribution of seismic forces according to fundamental mode shapes (Static, mode shape)

In this method the distribution of *base shear force* happens according to the base vibration shape (see EC8 4.3.3.2.3(2)P). The horizontal forces acting on the place of  $\mathbf{m}_i$  are:

$$F_i = F_b \frac{s_i m_i}{\sum s_j m_j}$$

where:  $s_i, s_j$  are the horizontal displacements of masses  $\mathbf{m}_i, \mathbf{m}_j$  in the fundamental mode shape.

The following table shows how to select the base vibration shape. The table contains all mode shapes (**No.**), the vibration time (**T(s)**) and effective masses of the mode shapes in **x'** and **y'** directions (**m<sub>x</sub>(%)** and **m<sub>y</sub>(%)**). As you can see the effective masses are given in a relative form to the total or reduced mass of the structure. The reduced mass means the total mass above the foundation or above the rigid basement. The value of the effective mass is referred to how the mode shape respond to a ground motion direction, so the effective mass shows the participation weight of the mode shape.

It is recommended to select that mode shape which gives the largest effective mass as the fundamental mode shape. The method allows to **Select** one mode shape in **x'** or/and **y'** direction(s).

### Remark:

The calculation of *base shear force* is performed according to the total mass of the structure and not the effective mass, as was introduced earlier in **Lateral force method**.

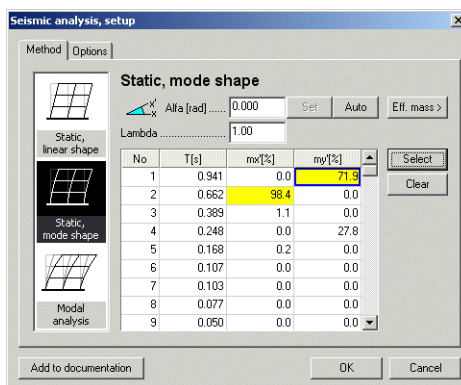



## Modal response spectrum analysis (modal analysis)

This method can be used in all national codes.

The essence of the method is the calculation of the structural response for different ground motions by the sufficient summation of more vibration shapes. Method gives possibility to take into account full **x**, **y** and **z** direction investigation. In the table below, more vibration mode shape could be selected in **x'**, **y'** and **z'** directions if necessary. The last row of the table shows that in a given ground motion direction how large is the sum of the considered effective masses compared to the total or reduced mass of the structure.

According to EC8 4.3.3.3.1(3) and NS3491-12 sum of the effective mass of the chosen mode shapes - at least in horizontal direction - should reach 90% of total mass. Additionally every mode shape has to be taken into account which effective mass is larger than 5%.

**Remarks:** If the sum of the effective mass is much smaller than 90%, eigen-frequency calculation should be done for more shapes in order to reach 90%.

In vertical direction lots of mode shapes should be ensured to reach the 90% of total mass; highly recommended to check the national code whether it is necessary to examine the vertical effect.

The mode shapes which have small effective mass may be neglected, because their effect in result is very small but the calculation time increases.

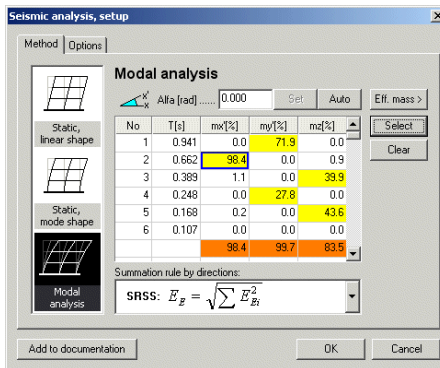

According to the EC8 and NS3491-12 the summation rule in the individual di-

rections can be selected in the lower part of the seismic analysis setup dialog. In all other codes there is no possibility to choose, the **SRSS** rule is used for summation.

According to EC8 4.3.3.3.2, the summation rule possibilities are the following:

Automatic
SRSS: $E_E = \sqrt{\sum E_{Ei}^2}$
CQC: $E_E = \sqrt{\sum \sum E_{Ei} \cdot r_{ij} \cdot E_{Ej}}$

where:  $E_E$  is the seismic action effect under consideration (force, displacement, etc.),

$E_{Ei}$  is the value of this seismic action effect due to the vibration mode  $i$ ,

$r_{ij}$  is the interaction between two vibration periods taking into account the declining ratio:

$$r_{ij} = \frac{8\xi^2(1+r)r^{3/2}}{(1-r)^2 + 4\xi^4r(1-r)^2} \quad \text{and } r = T_j / T_i$$

The **CQC** (Complete Quadratic Combination) summation rule might be adopted when individual direction, two vibration modes are dependent to each other if they satisfy the following condition:

$$T_j / T_i > 0,9 \quad \text{with } T_j \leq T_i$$

**FEM-Design** always applies the selected rule for the summation except if the **Automatic** is highlighted. If the **Automatic** is selected then the rule selection procedure is as follows:

- Always three directions (if there where more than one mode shape selected in that column) is investigated whether all mode shapes are independent from each other or not.
- If at least one dependent situation exists in a direction, the program automatically uses the **CQC** rule for all mode shapes in that direction, otherwise **SRSS** rule is used.

### 1.1.6.3.2 Other setting possibilities

#### Horizontal direction setting for seismic calculation

Generally codes speak about the seismic calculation in X-Y directions. However results in these directions give the maximum effect if the mass and elastic properties of the structure ensure that the calculated mode shapes lay in X-Z or Y-Z plane. Nevertheless it is not always achieved in practice. To achieve the unfavorable direction, where the results from a ground motion are maximum, the user can **Set** the **Alpha** angle or may get the program suggestion by using **Auto** button. The most unfavorable direction can be found when any of the  $m_x$ ,  $m_y$  is zero and the other is maximum in a row. Using **Auto** button, program gives the most unfavorable directions, but there are certain restrictions: this directions can be ensured only for one mode shape. The program selects the row where the effective mass is the maximum.

As an example, on the left hand side figure you can see a badly adjusted x'-y' direction. Applying **Auto** button, program arranges the direction for the 73,8% effective mass and correct it to 98,3%.

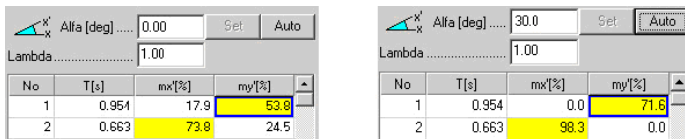

No	T[s]	$m_x$ [%]	$m_y$ [%]
1	0.954	17.9	53.8
2	0.663	73.8	24.5

  

No	T[s]	$m_x$ [%]	$m_y$ [%]
1	0.954	0.0	71.6
2	0.663	98.3	0.0

Of course this also can be reached if the user rotates the whole geometry with a specified angle.

#### Effective mass setting

**FEM-Design** always takes into account the entire mass of the structure in the calculation of *base shear force* which was mentioned in **Lateral force method**. It was also mentioned, EC8 defines the total mass without the basement, this is called **Reduced mass** in this manual. The effective masses are generally compared to the **Reduced mass**, but this is not valid for the massive basement with elastic foundation. If the above mentioned situation is the case, it might happen that the sum of the effective masses of a column is larger than 100%. The user may compare the modal effective masses to the total mass or reduced mass by pushing the **Eff. mass** button.

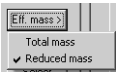

In **FEM-Design Reduced mass** means the difference between the total mass of the structure and the basement mass. The basement mass is the sum of all masses which lay on the *foundation level* which can be set in the **Others** tab of seismic load.

It is uninteresting from the calculation point of view that effective masses are compared to the total or the reduced mass because these values are given in percentage and only gives information about which mode shape is the fundamental or which shapes are dominant in a given direction.

### 1.1.6.3.3 Combination rule, rotation and second order effects

According to EC8 4.3.3.5, the combination rule of  $\mathbf{x}'$ ,  $\mathbf{y}'$  and maybe  $\mathbf{Z}$  direction effects, namely the seismic calculation of *final results* (*Seismic max.*), can be selected from the following two possibilities:

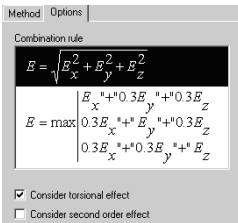

The first rule which is called **SRSS** is implemented to all the other codes than EC8 and NS3491-12 and there is no possibility for rule selection.

### Torsional effect

According to EC8 4.3.2 the program gives possibility to take into account the accidental mass distribution of the structure by the calculation of the torsional effect. This means that from the horizontal seismic forces a  $\mathbf{Z}$  directional torsional moment can be calculated according to EC8 4.3.3.3 (EC8 4.17 equation) as follows:

$$M_{ai} = e_{ai} F_i$$

where:  $M_{ai}$  is the torsional moment applied at the  $\mathbf{m}_i$  point about the vertical axis,

$e_{ai}$  is the accidental eccentricity of mass  $\mathbf{i}$  in accordance with expression (EC8 4.3 formulas) for all relevant directions:

$$e_{ai} = \pm 0,05 L_i$$

$\mathbf{L}_i$  is the floor-dimension perpendicular to the direction of seismic action ( $\mathbf{L}_{x',i}$  or  $\mathbf{L}_{y',i}$ ),

$\mathbf{F}_i$  is the horizontal force acting on the place of  $\mathbf{m}_i$  in  $\mathbf{x}'$  or  $\mathbf{y}'$  direction, when static method is used. In the modal analysis, this force is calculated, selecting the mode shape which gives the largest effective mass (fundamental shape). Using this mode shape this force is calculated according to *static, mode shape*. So, the total mass and not the effective mass of the structure is taken into account which belongs to this fundamental mode shape.

The explanation of the floor-dimension ( $\mathbf{L}_{x',i}$  and  $\mathbf{L}_{y',i}$ ) on the  $i^{\text{th}}$  storey:

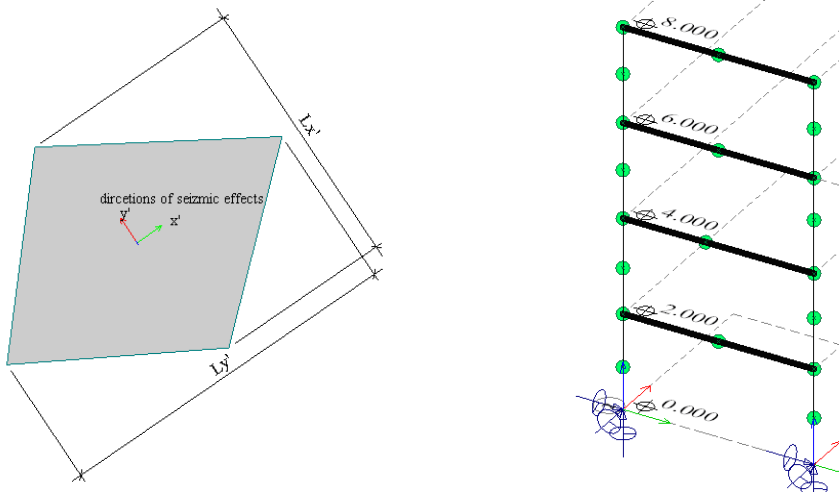

**Remarks:**

- To calculate the torsional effect, storey(s) should be defined.
- The accidental eccentricity of the masses which are not laid on the storey will be considered on the nearest storey's eccentricity.

It was seen that the influence of uncertainties of mass position was modeled by the rotation effect. According to our experiment using the **FE** method, when a plate, a wall and beams are divided into several elements the accidental torsional effect is not reasonable.

## Second-order effects (P-Δ effects)

Only EC8 gives a possibility to calculate the second order effect which is done according to 4.4.2.2(2). The second order effect is ignored if the following condition is fulfilled in all storeys and all horizontal directions:

$$\theta = \frac{P_{\text{tot}} d_r}{V_{\text{tot}} h} \leq 0.10$$

where:  $\theta$  is the interstorey drift sensitivity coefficient,

$P_{\text{tot}}$  is the total gravity load at and above the storey considered in the seismic design situation.

**Remark:** This total gravity load is calculated back from the nodal masses.

$d_r$  is the design interstorey drift, evaluated as the difference of the average lateral displacements  $d_s$  (see **Displacement calculation**) at the top and bottom of the storey under consideration and calculated in accordance with EC8 4.3.4,

$V_{\text{tot}}$  is the total seismic storey shear force,

$h$  is the interstorey height.

If  $0,1 < \theta \leq 0,2$ , the second order effect is taken into account by multiplying the relevant seismic action effects (the internal and reaction forces) by a factor equal to  $1/(1-\theta)$ .

According to EC8 4.4.2.2(4)P the  $\theta$  coefficient shall not exceed 0,3. When  $\theta > 0,3$ , **FEM-Design** sends a warning message and continues the calculation using  $\theta = 0,0$ .

The 0,2-0,3 interval is missing in EC8. In this case **FEM-Design** sends a warning message and continues the calculation using calculated  $\theta$ .

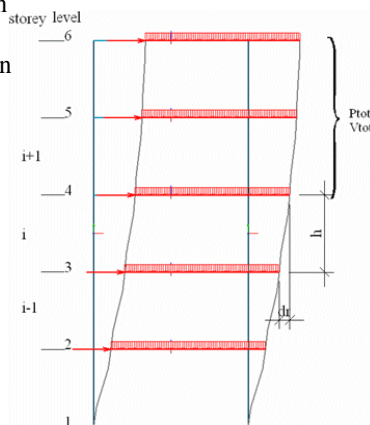

**Remark:** To calculate the second order effect, storey(s) should be defined.

### 1.1.6.3.4 Displacement calculation

The displacement calculation is made according to EC8 4.3.4 using the following formula:

$$d_s = q_d d_e$$

where  $d_s$  is the displacement of a point of the structural system induced by the design seismic action,

$q_d$  is the displacement behavior factor, assumed equal to  $q$  unless otherwise specified,

$d_e$  is the displacement of the same point of the structural system, as determined by a linear analysis based on the design response spectrum.

**FEM-Design** uses the above formula only to calculate the summarized and combined the so called *final results* displacements. The displacements obtained from the single shapes and torsional effects won't be modified.

### 1.1.6.4 The results of seismic calculation

The seismic results are very similar to statical results with some more items as follow: equivalent seismic forces and *base shear force*. The results shown separately from mode shapes, torsional effects, sum of the directions (**Sum, x'...**) and the *final results* (**Seismic max.**). Desired results can be selected from the result dialog as it is shown below. Among the equivalent load results not only the nodal forces can be seen but also the *base shear force*, and in case of torsional effect the total torsional moment as well.

Shape, dir.	F [M] [kN [kNm]]
Torsion, x'	35
Torsion, y'	21
1.shape, x'	27
Sum, x'	27
2.shape, y'	53
Sum, y'	53
3.shape, z'	12
5.shape, z'	32
Sum, z'	34
Seismic max.	68

**Remarks:** Because of the summation rule, the summarized values by direction and the full combinations give only positive values, namely these results means the maximum envelope.

Because of the summation rule, none of the displacement components in a node and none of the member's internal forces are not simultaneous.

### 1.1.6.5 Summation of static and seismic effects

The seismic effect's results can be considered together with static effects in two ways:

Seismic forces applied as real static forces in load cases,

The *final results* can be combined with a static load combination or taking into account in load groups.

#### 1.1.6.5.1 Seismic loads in static load cases

Horizontal seismic forces and torsional effects which were calculated using the static method according to EC8 or NS3491-12 additionally can be added to the static load cases. However it is recommended to have the seismic forces in separate load case(s) in order not to mix up them with the normal static loads.



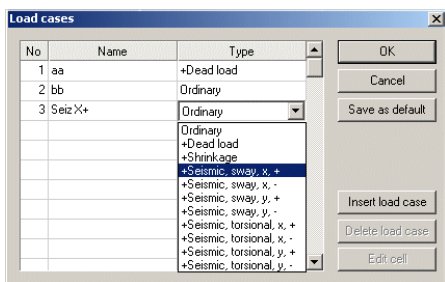

In the static calculations, load cases which contain seismic forces behave like the other normal static forces. Consequently they can be inserted in load combinations and load groups. If they are inserted in the load combinations then they can take part in the imperfection and stability analysis. Of course there is no possibility to convert the

masses from these load cases. As it can be seen in the table above, these effect can be taken into account by positive or negative sign as well, because the seismic effect means vibration between +/- extreme values, but the results are shown only in positive direction for the sake of simplicity. As it is shown above all the seismic possible cases can be found in the list but only those cases are valid which were calculated in seismic calculation. The calculated static loads from seismic effect can be found among the seismic results in the **Equivalent loads**.

### 1.1.6.5.2 Final results of seismic effect (Seismic max.) in load combination

*Final results* of seismic effect (**Seismic max.**) always obtained from the total summation of all components. These results which actually means extreme +/- values, can be added to a load combination as a special load case with arbitrary factor and it can be applied in all codes.

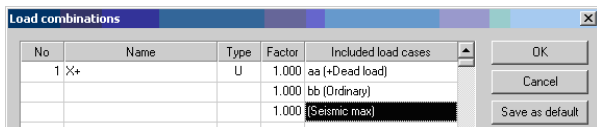

The combination of the **Seismic max.** and the other static loads results is calculated in a special way.

Because the results of the seismic effect are always positive and individual components (e.g.  $N$ ,  $M_y$  and  $M_z$  internal forces in bar) are not simultaneous **FEM-Design** takes action as follow:

*All components of the seismic results are added to the components of static results with the sign of static component.*

### 1.1.6.5.3 Final results of seismic effect (Seismic max.) in load groups

*Final results* of seismic effect (**Seismic max.**) can be applied in load groups in all codes. Using EC8 and NS3491-12 program give possibility to have **Seismic** load type beside **Permanet**, **Temporary** and **Accidental** load type. In all other codes it is recommended to apply the **Seismic** load type in the **Accidental** load type. The *final results* of seismic effect take part with +/- sign automatically in the load group combination.

No	Load group	Included load cases
1	aa (Perm., 0.90, 1.10, 1.00, 1.35)	aa (+Dead load)
2	bb (Temp., 1.35, 0.70, 0.50, 0.30)	bb
3	Seismic (Seismic, 1.00)	(Seismic max)

### 1.1.6.6 Useful tips, which method to use?

To answer this question is hard even for experienced engineers. However some basic concept can be formulated:

Before any decision, always run the **Eigenfrequencies** calculation. From this results you will experience how the structure behaves in aspect of dynamics,

Always check the effective masses, if you calculate the structure for seismic effect in the first occasion or make changes in the geometry or in the mass distribution,

If you see that the effective masses shows larger value than 100% compare them to the **Total mass** and not to the **Reduced mass**,

If the sum of the selected effective masses is less than the prescribed minimum (in EC8 this is 90%), calculate more mode shape,

If the sum of effective masses in case of large number mode shapes doesn't approach to the prescribed value use the *static*, *linear shape* or *static, mode shape* if the code allow,

If the building has large importance or it has special geometry try to apply the modal analysis,

If the building is not too high, any of the static methods will give reliable results avoiding longer run time calculation in eigenfrequenc,

It is not always necessary to analyze the 3D model in all directions, sometimes one or two planar model is enough.

## 1.1.7 Non-linear calculation

### 1.1.7.1 Uplift calculation

In the **Wall** and **Plate** modules of **FEM-Design** there is a possibility to define point, line and surface supports resisting only compression. This is a problem with material non-linearity which can be solved with the iterative method. In this case the relationship between reaction forces and displacements can be interpreted by the following diagram.

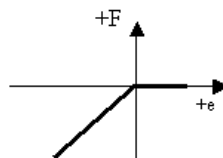

The solution implemented in **FEM-Design** is very simple:

In the first step, when supports also resist tension, it is checked if tension appeared in any support. If yes, and the support is defined to resist only compression, then the linear static analysis is repeated with setting the stiffness values in the tensioned elements to a very small value. We repeat this procedure until there is no tensioned support any more.

If the user defines this kind of supports, he has to be aware of the direction (local coordinate system) of them, furthermore to the fact that the structure can become kinematically undetermined.

### 1.1.7.2 Crack analysis in FEM-Design Plate

In **FEM-Design** a crack analysis technique is applied, where an iteration mechanism is calculating the effect of the cracks.

As the crack analysis is a non-linear calculation the principle of superposition is not true. By this fact the crack analysis is not applicable for load groups and the calculation has to be executed for every single combination.

Generally the iteration is loading the structure in load steps, and modifies the stiffness of it in every step as more and more cracks occur during the loading process. The stiffness of the plate will be decreased only in the direction that is perpendicular to the crack lines, in the direction of the crack lines the stiffness remains the same as for the uncracked state. The key of the calculation is the way the crack direction is calculated in a certain point. Dr. Ferenc Németh from the Technical University of Budapest has invented a method for this which is based on experiments. The cracked stiffness calculation is based on a conventional cross section modulus calculation of the second crack state which is combined with a Eurocode like crack distribution calculation (to consider the effect of uncracked parts of the plate between two cracks).

The calculation for one combination is performed in the following steps:

- Loading the structure with the loads of the combination and performing a linear calculation of the internal forces.
- Calculating the moment that cause crack on the structure in every points of the plate. This value is calculated by the tensional strength (limit stress) of the plate's concrete material, the reinforcements are not taken into account at this point.
- Searching for the place where the ratio of the crack moment and the actual (linear) moment has the smallest value. This value will describe the initial level of the load for the iteration. The size of a load step is calculated by user defined values.
- In the first step the initial load acts and is then increased by the calculated load steps.
- In every step is calculated whether the plate is cracked or not in a certain point (comparing the smallest principal moment to the crack moment of the plate). If the plate is cracked the direction of the crack is calculated and the stiffness of the cracked section. The element where the crack occurs then will have reduced stiffness. In the next load step it will change the behaviour of the plate as the crack does in the real structure.

- When the full load is applied on the structure the calculation is continued with full load level to consider cracks occurring in the last load step and to have a stable result. This phase is called final iteration. The final iteration is finished when the differences of the sum of the movements are less than a certain error percentage between two steps. The initial error percentage is 1% compared to the previous step, but this value could be adjusted.

**Notes:**

- It is possible that the plate is cracked in two direction in the same side. This is the case when the largest as well as the smallest principal value is over the crack limit. In this case the stiffness of the plate will be decreased in both directions (parallel and perpendicular to the crack line).
- It also can happen that the plate is cracked on both sides of it, but in this case the crack lines are nearly perpendicular to each other (depends on the reinforcement parameters).
- During the calculations the direction of the cracks and the stiffness of the cracked parts are recalculated in every step. This is because the cracks makes changes in the behaviour of the structure, and depending on this the moment distribution is changed continuously along the structure. By numerical reasons the newly calculated directions and stiffnesses are not applied immediately with their full value but an intermediate value is used between the previous and the newly calculated values. This well known technique makes the calculation longer but the chance of success is increased. This technique is one reason why a final iteration is needed.
- As the numerical techniques are mandatory to get correct results and these techniques are affected by the structural conditions and by user defined values the user should be warned that a certain load step and final error value which is good for one structure perhaps is not suited for another structure. Smaller load steps means generally more accurate results, but the price is longer calculation time.
- The crack direction calculation is based on the least remaining moments method. This method suppose that the crack direction will be the same as the crack when the capacity of the plate is reached. In every investigated point the moments are increased virtually (multiplied with a certain va-

lue) until the yield state is reached. The method of Ferenc Németh can describe the crack line direction on this level.

- The stiffnesses of the cracked sections can be described in the directions of the reinforcements but the cracks occur in any direction. To calculate the stiffness perpendicular to the crack lines an average calculation method invented by Dr. Ferenc Németh is used. The technique is based on experiments.
- By the limitation of the finite element method the internal force distribution will not be as smooth as can be seen for un-cracked structures, there would be small peaks on the border of two elements that have different crack direction and/or stiffness which is a normal state during crack analysis.

## 1.1.8 Finite elements

### 1.1.8.1 2D plate

The 2D plate element has almost the same properties as the 3D plane shell element with one important difference: it is capable only of calculation of bending effects. The following section contains only the differences.

The element is planar, the plane of the structure is the **XY** plane, its loads are perpendicular to its plane. It is capable of calculation of bending and torsional moments and cross-directional shear forces. Degree of freedom of nodes are 3,  $w$  is the displacement in **Z** direction,  $\varphi_x$  and  $\varphi_y$  are rotation around **X** and **Y** axis, respectively. Interpolation of the displacement function is quadratic. The element with 8 nodes is wellknown in the literature as serendipity element.

At definition of bedding (surface supports) it is possible to set them to resist only pressure (see non-linear calculation).

Material of the plate is orthotropic, relationship between strains and stresses are as follows:

$$\begin{bmatrix} \varepsilon_r \\ \varepsilon_s \\ \gamma_{rs} \\ \gamma_{rz} \\ \gamma_{sz} \\ w_z \end{bmatrix} = \begin{bmatrix} 1/E_r & -\nu_{rs}/E_r & 0 & 0 & 0 & 0 \\ & 1/E_s & 0 & 0 & 0 & 0 \\ & & 1/G_{rs} & 0 & 0 & 0 \\ & & & 1/G_{rz} & 0 & 0 \\ & & & & 1/G_{sz} & 0 \\ & & & & & 1/k \end{bmatrix} \begin{bmatrix} \sigma_r \\ \sigma_s \\ \tau_{rs} \\ \tau_{rz} \\ \tau_{sz} \\ p_z \end{bmatrix}$$

Since the matrix of the material constants are symmetrical:

$$\nu_{rs} / \nu_{sr} = E_r / E_s$$

The  $k$  constant in the last row is the Winkler-type bedding factor.

The element is loadable in the same way as the 3D plane shell element, according to common sense.

### Results:

- $w, \varphi_x, \varphi_y$  displacement and rotations of nodes,
- $M_x, M_y$  specific bending moments in the global **X-Y** coordinate system,
- $M_{xy}$  torsional moment,
- $T_x, T_y$  cross directional shear forces,
- $F_z$  bedding (support) surface distributed forces.

The extremes of the stresses can be calculated from the above mentioned internal forces according to the following relationships ( $t$  is the thickness of the plate):

$$\sigma_x = 6 M_x / t^2, \sigma_y = 6 M_y / t^2$$

$$\tau_{xz} = 3 T_x / (2t), \tau_{yz} = 3 T_y / (2t), \tau_{xy} = 6 M_{xy} / t^2$$

### 1.1.8.2 2D wall

The 2D wall element, (also called disk element) has almost the same properties as the 3D plane shell element but it is capable only of calculation of the membrane effect. The following section contains only the differences.

The element is planar, the plane of the structure is the **XY** plane, its loads act in its plane, too. Degree of freedom of the nodes is 2: **u** and **v**, displacements in the **X** and **Y** directions. Interpolation of the displacement function is quadratic. The element with 8 nodes is wellknown in the literature as serendipity element.

The element is capable of calculation on plane stress or plane strain state.

Material of the plate is orthotropic, relationship between strains and stresses are as follows:

In case of plane stress state:

$$\begin{bmatrix} \varepsilon_y \\ \varepsilon_s \\ \gamma_{ys} \end{bmatrix} = \begin{bmatrix} \frac{1}{E_y} & -\frac{\nu_s}{E_y} & 0 \\ & \frac{1}{E_s} & 0 \\ & & \frac{1}{G_{ys}} \end{bmatrix} \begin{bmatrix} \sigma_y \\ \sigma_s \\ \tau_{ys} \end{bmatrix}, \text{ and}$$

$$\sigma_z = 0, \quad \varepsilon_z = -\frac{\varepsilon_r}{\nu_{rz}} - \frac{\varepsilon_s}{\nu_{sz}}$$

In case of plane strain state:

$$\begin{bmatrix} \varepsilon_r \\ \varepsilon_s \\ \gamma_{rs} \end{bmatrix} = \begin{bmatrix} \frac{1}{E_y} - \frac{E_z \nu_{rz} \nu_{yz}}{E_y^2} & -\frac{\nu_{ys}}{E_y} - \frac{E_z \nu_{yz} \nu_{sz}}{E_y E_s} & 0 \\ & \frac{1}{E_s} - \frac{E_z \nu_{sz} \nu_{yz}}{E_y^2} & 0 \\ & & \frac{1}{G_{ys}} \end{bmatrix} \begin{bmatrix} \sigma_r \\ \sigma_s \\ \tau_{rs} \end{bmatrix}$$

Results:

The result of the calculation for a given element in the nodes are as follows:

- $\sigma_x, \sigma_y$  normal stresses in the **X-Y** plane,



- $\sigma_z$  normal stress in the **Z** direction (only in case of plane strain state)
- $\tau_{xy}$  shear stress,
- $\sigma_1, \sigma_2, \sigma_3$ : principal stresses,
- $\sigma_{VM}$  the so called von Mises stress, which is calculated according to the following form:

$$\sigma_{vm} = \sqrt{((\sigma_3 - \sigma_1)^2 + (\sigma_3 - \sigma_2)^2 + (\sigma_1 - \sigma_2)^2)/2}$$

The internal forces in the nodes of the connected elements are averaged over every region one by one.

The sign rule of the internal forces:

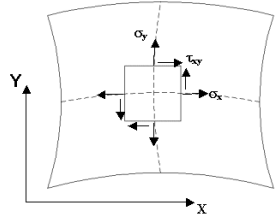

### 1.1.8.3 2D beam

The 2D beam element is a prismatic element with two nodes and straight axis. It is capable of calculation of beam-grids lying in the **X-Y** plane, loaded in **Z** direction, and in case of bent 2D slab structures for modelling of stiffening ribs and lintels. The applied (Timoshenkó-type) bar element has three degrees of freedom: **w**, the displacement in the global **Z** direction and  $\varphi_x, \varphi_y$  rotations. The shear deformations are taken into consideration similarly to the 3D element. Interpolation of the displacement function is implemented by polinomes of the third degree.

In the case of bent slab structures the element can be eccentric in the global **Z** direction, as it is represented in the following picture.

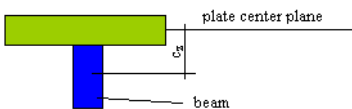

In this case the bar element behaves like an element with inertia increased by the Steiner part, which gives correct results for the displacement of the slab structure from engineering point of view. However in this

case the internal forces of the elements are calculated as a 3D bar element.

The possible loads and the results are appropriately the same as in case of the 3D beam element.

### 1.1.8.4 3D shell

The 3D slab element is an isoparametrical, thick shell element with eight or six nodes, which can be used for modelling of spatial structures containing parts with plane centre surfaces. The element is capable of calculation of membrane (in-plane) and bending (perpendicular to plane) displacements and matching same time (engaged) internal forces. The number of degree of freedom is six per node:  $\mathbf{u}$ ,  $\mathbf{v}$ ,  $\mathbf{w}$  displacements and  $\varphi_X$ ,  $\varphi_Y$ ,  $\varphi_Z$  rotations, referring to the  $\mathbf{X}$ ,  $\mathbf{Y}$ ,  $\mathbf{Z}$  directions of the global coordinate system. Interpolation of displacement functions is implemented by second order functions. In all elements beside the eight nodes on the perimeter there is a ninth node in the centre of the element, which is invisible to the user. The interpolation function belonging to the ninth node is the so called bubble-function, which is zero on the perimeter of the element. It only has a role in the elimination of numerical problems during the calculations (shear locking, membrane locking). Applying the thick shell theory makes it possible to calculate the shear effect more accurately perpendicular to the plane.

As a result of application of shell theory (or more accurately Kirchoff hypothesis referring to displacements) the rotation stiffness of the structure perpendicular to the centre plane is zero. It only has effect if the analyzed structure is a plane slab. In this case the rotation around the normal direction of the plate has to be fixed in at least one point additional to the statically determined support of the slab. It is unnecessary, if the structure it self fixes this rotation, i.e. beams or columns connected to the slab, or the structure contains more connected slabs with not parallel centre plane. If the whole structure is in one plane, it is more practical to use wall or plane plate element, because it eliminates the above mentioned problem, moreover the number of degree of freedom of the structure is much lesser at the same element division and calculation accuracy. The thickness of the element can vary linearly. The elastic surface bedding is taken into consideration according to the linear Winkler model, which also allows the bedding factor to vary linearly.

Application of the element requires the usage of three different Descartes coordinate systems. Coordinates of nodes, certain type of loads and node displacements among the results are defined in the global (structural)  $\mathbf{X}$ ,  $\mathbf{Y}$ ,  $\mathbf{Z}$  system. The calculated internal forces can be defined in the local (region)  $\mathbf{x}$ ,  $\mathbf{y}$ ,  $\mathbf{z}$  system, where  $\mathbf{z}$  is the normal direction of the region and finally the  $\mathbf{r}$ ,  $\mathbf{s}$ ,  $\mathbf{z}$  system defines the main directions of orthotropy.

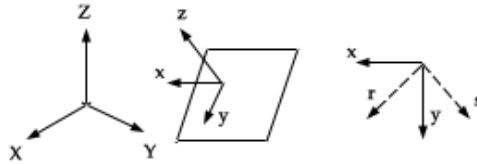

In case of orthotropic material the  $\mathbf{r}$ ,  $\mathbf{s}$  axes lying in the centre plane define the material main directions. In this system the relationship between deformations and stresses is the following (Hook law):

$$\begin{bmatrix} \sigma_r \\ \sigma_s \\ \tau_{rs} \\ \tau_{rz} \\ \tau_{tz} \end{bmatrix} = \begin{bmatrix} D_{11} & D_{12} & 0 & 0 & 0 \\ D_{21} & D_{22} & 0 & 0 & 0 \\ & & D_3 & 0 & 0 \\ & & & D_4 & 0 \\ & & & & D_5 \end{bmatrix} \begin{bmatrix} \varepsilon_r \\ \varepsilon_s \\ \gamma_{rs} \\ \gamma_{rz} \\ \gamma_{tz} \end{bmatrix}$$

where, since

$$D_{11} = E_r / (1 - \nu_{rs} \nu_{sr}) = E_r / (1 - \nu_{sr}^2 E_s / E_r), \quad D_{22} = E_s / (1 - \nu_{sr}^2 E_s / E_r)$$

$$D_{12} = D_{21} = \nu_{sr} E_s / (1 - \nu_{sr}^2 E_s / E_r),$$

$$D_3 = G_{rs}, \quad D_4 = G_{rz}, \quad D_5 = G_{sz}$$

The thermal expansions in direction of  $\mathbf{r}$ ,  $\mathbf{s}$  axes developed by  $\mathbf{T}$  temperature:

$$\begin{bmatrix} \varepsilon_r \\ \varepsilon_s \end{bmatrix} = \begin{bmatrix} \alpha_r & 0 \\ 0 & \alpha_r \end{bmatrix} \begin{bmatrix} 1 \\ 1 \end{bmatrix} T$$

In case of isotropic material two material constants,  $\mathbf{E}$  and  $\mathbf{u}$  define the elastic material property:

$$D_{11} = D_{22} = E / (1 - \nu^2), \quad D_{12} = D_{21} = \nu E / (1 - \nu^2),$$

$$D_3 = D_4 = D_5 = E / (2 + 2\nu) = G, \quad \text{and}$$

$$\alpha_r = \alpha_s = \alpha$$

### Loads:

- Gravity (dead) loads, in the downward vertical direction, by default the global  $-\mathbf{Z}$ ,
- Forces and moments acting on one point, in any point of the structure,
- Linearly varying line load,
- Linearly varying surface load (pressure),
- Thermal load linearly varying along the surface and along the element

thickness,

- Support motions at the rigid or elastic surface and point supports.

### Results:

- Displacements and rotations in the global ( $\mathbf{X}, \mathbf{Y}, \mathbf{Z}$ ) coordinate system,
- Eight internal force and five stress coordinates in the local ( $\mathbf{x}, \mathbf{y}, \mathbf{z}$ ) coordinate system.

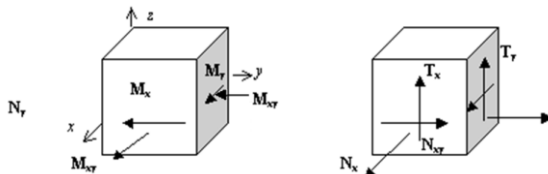

Calculated internal forces (force and moment referring to unit length):

- $\mathbf{M}_x, \mathbf{M}_y$  bending moments,
- $\mathbf{M}_{xy}$  torsional moment,
- $\mathbf{T}_x, \mathbf{T}_y$  cross directional shear force,
- $\mathbf{N}_x, \mathbf{N}_y, \mathbf{N}_{xy}$  membrane forces.

Variation of stress coordinates along the thickness can be calculated from the internal forces according to the following relationships:

$$\sigma_x = \frac{N_x}{t} - \frac{M_x}{I_1} z, \quad \sigma_y = \frac{N_y}{t} - \frac{M_y}{I_1} z, \quad \tau_{xy} = \frac{N_{xy}}{t} - \frac{M_{xy}}{I_1} z,$$

$$\tau_{xz} = \frac{T_x}{2I_1} \left( \frac{t^2}{4} - z^2 \right), \quad \tau_{yz} = \frac{T_y}{2I_1} \left( \frac{t^2}{4} - z^2 \right),$$

$$I_1 = \frac{t^3}{12}, \quad -\frac{t}{2} \leq z \leq \frac{t}{2}$$

where  $t$  is the element thickness.

### 1.1.8.5 3D beam

The beam element is an element with two nodes which has a straight axis. It is usable for analysis of spatial trusses and structures containing bars among others. The number of degree of freedom is six per node:  $\mathbf{u}, \mathbf{v}, \mathbf{w}$  displacements and  $\varphi_x, \varphi_y, \varphi_z$  rotations, referring to the  $\mathbf{X}, \mathbf{Y}, \mathbf{Z}$  directions of the global coordinate system. The applied (Timoshenko) bar theory also makes it possible to take into

consideration the shear deformations. Interpolation of displacement and rotation functions are implemented by the third order polynomials.

Application of the element requires the usage of four different Descartes coordinate systems. Coordinates of nodes, certain type of loads and node displacements among the results are defined in the global (structural)  $\mathbf{X}, \mathbf{Y}, \mathbf{Z}$  system. The  $\mathbf{x}, \mathbf{y}, \mathbf{z}$  local coordinate system fits to the node, where  $\mathbf{x}$  is parallel with the axis of the bar element, and  $\mathbf{y}, \mathbf{z}$  define the plane of the cross-section. The calculated internal forces can be defined in the  $\mathbf{x}', \mathbf{y}', \mathbf{z}'$  axes, originated from the centre of gravity, which are parallel with  $\mathbf{x}, \mathbf{y}, \mathbf{z}$ , respectively. In the plane of the cross-section  $\mathbf{x}$  and  $\mathbf{h}$  axes, originated from the centre of gravity, define the cross-sectional main directions.

Cross-section of the element is arbitrary but its size and orientation is constant along one element. Since the node (connection point) and the centre of gravity can be different in a cross-section, this element is capable of analysis of structures containing bars with eccentric connections.

A typical structure for this case is a ribbed slab. In this case the node of the rib (bar) element is on the centre plane of the slab but the centre of gravity of the bar can differ from it.

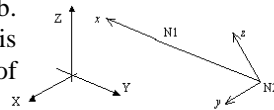

**Loads:**

- Gravity (dead) loads, in the downward vertical direction, by default the global- $\mathbf{Z}$ ,
- Forces and moments acting on one point, in any point of the structure,
- Linearly varying line load,
- Thermal load linearly varying along the length and along the cross-section,
- Support motions at the rigid or elastic point supports.

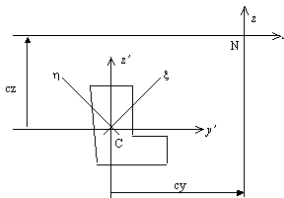

**Results:**

- Displacements and rotations in the global ( $\mathbf{X}, \mathbf{Y}, \mathbf{Z}$ ) coordinate system,
- Six internal forces in the local ( $\mathbf{x}', \mathbf{y}', \mathbf{z}'$ ) coordinate system, with its origin in the centre of gravity,
- $\mathbf{M}_y, \mathbf{M}_z$  bending moments,

- $M_x$  torsional moments,
- $V_y, V_z$  shear forces,
- $N_z$  normal force.

### 1.1.8.6 3D solid

These 3D elements are isoparametric solid elements with 4/10 nodes (Tetra), 6/18 nodes (Wedge) or 8/27 nodes (Brick), which can be used for modeling of spatial structure. The number of degree of freedom is three per node:  $u, v, w$  displacements. Interpolation of displacement functions is implemented by linear (4/6/8 node) or second-order (10/18/27 node) function (standard/fine).

The numerical integration method is performed in a full manner for element stiffness. The element node numbers and the integration schemes are the following:

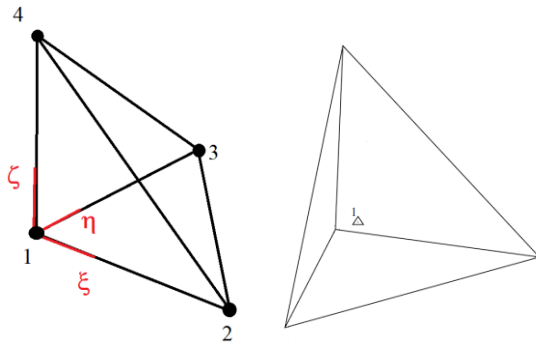

4 node tetra element, parametric coordinate system, node numbering and integration point (1 pc)

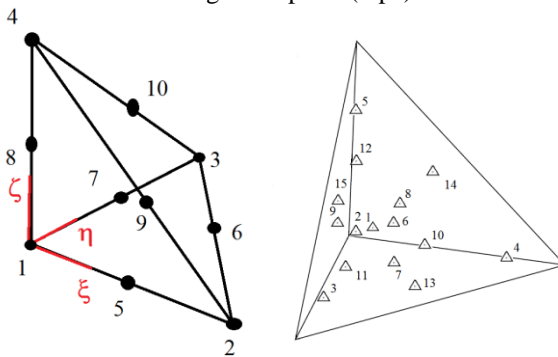

10 node tetra element, parametric coordinate system, node numbering and integration points (15 pcs)

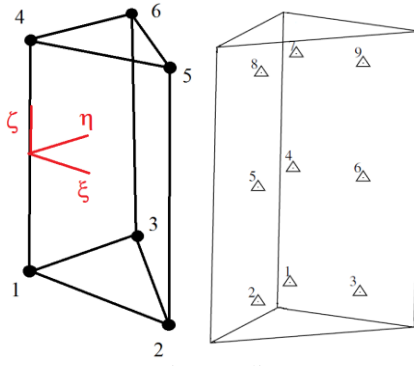

6 node wedge element, parametric coordinate system, node numbering and integration points (9 pcs)

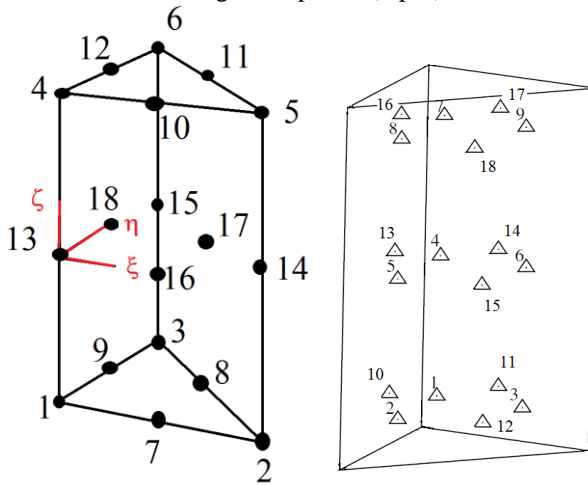

18 node wedge element, parametric coordinate system, node numbering and integration points (18 pcs)

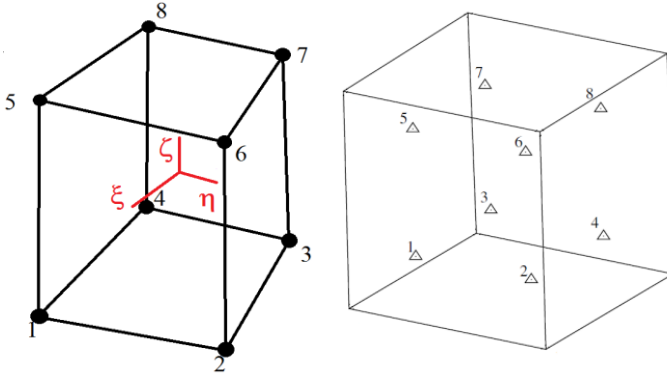

8 node brick element, parametric coordinate system, node numbering and integration points (8 pcs)

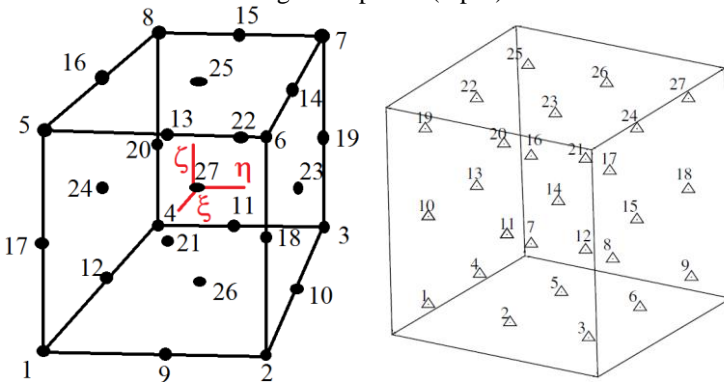

27 node brick, parametric coordinate system, node numbering and integration points (27 pcs)

Application of the element requires the usage of two different Cartesian coordinate systems.

- Coordinates of nodes, certain type of loads and nodal displacements among the results are defined in the global (structural)  $\mathbf{X}$ ,  $\mathbf{Y}$ ,  $\mathbf{Z}$  system.
- The  $\mathbf{x}$ ,  $\mathbf{y}$ ,  $\mathbf{z}$  system defines the main directions of orthotropy. In this system the relationship between deformations and stresses is the following (based on Hooke's law):

$$A = (I - 2\nu_{yz}\nu_{zx}\nu_{xy} - \nu_{yz}\nu_{zy} - \nu_{zx}\nu_{xz} - \nu_{xy}\nu_{yx})$$



$$\begin{bmatrix} \sigma_x \\ \sigma_y \\ \sigma_z \\ \tau_{yz} \\ \tau_{xz} \\ \tau_{xy} \end{bmatrix} = \begin{bmatrix} E_x \frac{(1-\nu_{yz}\nu_{zy})}{A} & E_x \frac{(\nu_{yx} + \nu_{yz}\nu_{zx})}{A} & E_x \frac{(\nu_{zx} + \nu_{yx}\nu_{zy})}{A} & 0 & 0 & 0 \\ E_y \frac{(\nu_{xy} + \nu_{zy}\nu_{xz})}{A} & E_y \frac{(1-\nu_{zx}\nu_{xz})}{A} & E_y \frac{(\nu_{zy} + \nu_{xy}\nu_{zx})}{A} & 0 & 0 & 0 \\ E_z \frac{(\nu_{xz} + \nu_{xy}\nu_{yz})}{A} & E_z \frac{(\nu_{yz} + \nu_{xz}\nu_{yx})}{A} & E_z \frac{(1-\nu_{xy}\nu_{yx})}{A} & 0 & 0 & 0 \\ 0 & 0 & 0 & G_{yz} & 0 & 0 \\ 0 & 0 & 0 & 0 & G_{zx} & 0 \\ 0 & 0 & 0 & 0 & 0 & G_{xy} \end{bmatrix} \begin{bmatrix} \varepsilon_x \\ \varepsilon_y \\ \varepsilon_z \\ \gamma_{yz} \\ \gamma_{xz} \\ \gamma_{xy} \end{bmatrix}$$

The connection between the local and global coordinate system is the following:

$$\underline{T} \cdot \begin{bmatrix} x \\ y \\ z \end{bmatrix} = \begin{bmatrix} X \\ Y \\ Z \end{bmatrix}; \underline{T} = \begin{bmatrix} T_{11} & T_{12} & T_{13} \\ T_{21} & T_{22} & T_{23} \\ T_{31} & T_{32} & T_{33} \end{bmatrix}, \text{ where } \underline{T} \text{ is the transformation matrix.}$$

The thermal expansions in direction of  $\mathbf{x}$ ,  $\mathbf{y}$ ,  $\mathbf{z}$  axes developed by  $\Delta T$  temperature:

$$\begin{bmatrix} \varepsilon_x \\ \varepsilon_y \\ \varepsilon_z \end{bmatrix} = \begin{bmatrix} \alpha_x & 0 & 0 \\ 0 & \alpha_y & 0 \\ 0 & 0 & \alpha_z \end{bmatrix} \begin{bmatrix} 1 \\ 1 \\ 1 \end{bmatrix} \Delta T$$

In case of isotropic material two material constants,  $E$  and  $\nu$  define the elastic material property:

$$\begin{bmatrix} \sigma_x \\ \sigma_y \\ \sigma_z \\ \tau_{yz} \\ \tau_{xz} \\ \tau_{xy} \end{bmatrix} = \begin{bmatrix} \frac{E(1-\nu)}{(1+\nu)(1-2\nu)} & \frac{\nu E}{(1+\nu)(1-2\nu)} & \frac{\nu E}{(1+\nu)(1-2\nu)} & 0 & 0 & 0 \\ \frac{\nu E}{(1+\nu)(1-2\nu)} & \frac{E(1-\nu)}{(1+\nu)(1-2\nu)} & \frac{\nu E}{(1+\nu)(1-2\nu)} & 0 & 0 & 0 \\ \frac{\nu E}{(1+\nu)(1-2\nu)} & \frac{\nu E}{(1+\nu)(1-2\nu)} & \frac{E(1-\nu)}{(1+\nu)(1-2\nu)} & 0 & 0 & 0 \\ 0 & 0 & 0 & G & 0 & 0 \\ 0 & 0 & 0 & 0 & G & 0 \\ 0 & 0 & 0 & 0 & 0 & G \end{bmatrix} \begin{bmatrix} \varepsilon_x \\ \varepsilon_y \\ \varepsilon_z \\ \gamma_{yz} \\ \gamma_{xz} \\ \gamma_{xy} \end{bmatrix}$$

where  $G = \frac{E}{2(1+\nu)}$ ,  $\alpha_x = \alpha_y = \alpha_z = \alpha$ .

### Loads:

- Gravity (dead) loads, in the downward vertical direction, by default the global -  $\mathbf{Z}$

- Forces acting on one point, in any point of the structure, in global system
- Linearly varying line load, in global system
- Linearly varying surface load (pressure), in global system
- Thermal load linearly varying along the elements
- Shrinkage load, in  $x$ ,  $y$ ,  $z$  direction
- Support motions at the rigid or elastic surface and point supports.

### Results:

- Displacements in the global ( $X$ ,  $Y$ ,  $Z$ ) coordinate system
- Six stress components in the global ( $X$ ,  $Y$ ,  $Z$ ) coordinate system.

#### 1.1.8.7 Point support

The element is a point-like elastic support element with 6 degrees of freedom, meant in local coordinate system. In the general case it can be defined by 3-3 stiffnesses against motions and rotations. It is possible to make the element to resist only compression (see non-linear calculation). In case of infinitely rigid supports the program modifies the stiffness coefficients in order to avoid numerical problems and substitutes them with proper values for the calculation.

The element can be loaded by support motion but only if it resists both tension and compression. The results of the elements are line reaction forces and moments in the local coordinate system of the element.

The reaction forces are positive in case of extension of the spring, and negative at compression.

#### 1.1.8.8 Line support

Spatial, line aligned, elastic support element with 6 degrees of freedom per node.

The element is isoparametric, has 3 nodes in order to fit the surface elements, always meant in local coordinate system. The degrees of freedom for a node of the element:  $u$ ,  $v$ ,  $w$ ,  $\varphi_x$ ,  $\varphi_y$ ,  $\varphi_z$ . There is possibility to make the element resist only tension (see non-linear calculation). In case of infinitely rigid supports the program modifies the stiffness coefficients in order to avoid numerical problems and substitutes them with proper values for the calculation. The 3D element can be defined by 3-3 stiffnesses against motion and rotation which are constant along the given line. In the 2D modules (i.e. **Plate**, **Wall**) only the appropriate stiffnesses can be defined and only they are considered during the calculation.

For example, in the **Wall** module only stiffnesses against motion in **x** and **y** directions can be defined.

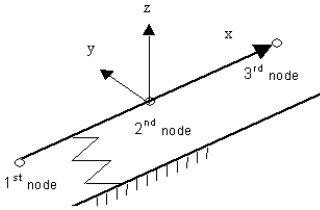

The element can be loaded by support motion but only if it resists both tension and compression. The results of the elements are line reaction forces and moments distributed along the length of the element according to quadratic function.

They are always meant in the local coordinate system of the element. The reaction forces are positive in case of extension of the spring, and negative at compression.

## **1.1.9 Finite element mesh**

### **1.1.9.1 Generate**

This sophisticated multi-phased mesh generating tool will consider the defined minimum division numbers and the average element sizes and will generate the most balanced mesh. The tool generates a so-called unstructured mesh. After selecting the regions where the mesh will be generated, the tool splits the regions into sub-regions and performs the multi-phased mesh generation.

The phases of mesh generation are:

- Defining the vertices of the elements.
- Creating a triangle mesh using the vertices.
- Converting the triangle mesh to mixed quadrate-triangle mesh.
- Optimizing the coordinates of the nodes in the mesh (smoothing the mesh).
- Setting the middle points of the element sides.

#### **Defining the vertices of the elements**

The vertices will be evenly placed to a distance of the average element size from each other along the lines, which are parallel with the longest edge of the sub-region and are at the average element size distance from each other.

#### **Creating a triangle mesh using the vertices**

The triangles are created using the well-known Delaunay triangulation technique which uses the Voronoi domains.

#### **Converting the triangle mesh to mixed quadrate-triangle mesh**

The function used to convert the triangle mesh to a mixed quadrate-triangle mesh is capable of creating the mesh with the globally optimal shape. This involves the solving of a linear programming problem known in the mathematics as assignment problem. Our mathematicians have developed a new procedure to find the optimum for the linear programming problem. This problem is similar to the distribution method procedure.

### **Optimizing the co-ordinates of the nodes in the mesh (smoothing the mesh)**

The optimization of the mesh is based on Dr. István Kirchner's new procedure, which was published in [10]. This procedure places the nodes of the triangle elements in such a way, that the area of the triangles will be balanced. In achieving the most balanced area of the triangles an iteration technique is used.

### **Setting the middle points of the element sides**

In the present version the sides of the elements are straight lines. Nodes are placed in the middle of the element sides.

The automatic mesh generator has some other unique and special automatic feature. Some of the most important features are:

- If the need arises the mesh will automatically be thicker around some local effects. This is solved by placing new nodes in the critical places. If the generator has found a place on the structure, where the mesh needs to be thicker, in the third phase of the generation the number of the iterations will be greater than 1. If the required thickness couldn't be achieved during the maximal iterations, the user will be notified with a warning. In this case, the geometrical structure possibly has some serious geometrical anomalies. The mesh around the places, where the geometrical anomalies are present will be very dense.
- If the calculated or user-set average element size is too big, than the generator will automatically recalculate and reduce it with the statistical analysis of the current mesh. In this case the mesh generator will restart the first phase of the generation after finishing the second. It is possible for the generator to execute the reduction of element size as many times as it is needed.
- During the mesh generation on the actual sub-region the generator takes into account the division number of the sub-region borders which belong to another sub-region. If the division number of a border, which belongs to another sub-region too is altered, the generator automatically regenerates the mesh on the other sub-region too. The visible sign of this automatic recalculation is that in the progress window the original number of the total sub-regions increases. If the automatic recalculation of the sub-regions is needed too many times, it may suggest some serious geometrical and statical problems on the structure. The critical places on the structure are marked by the

unusual density of the mesh. In order to minimise the number of the automatic recalculation the generator first resolves the sub-region with the smallest average element size and than proceeds in increase order.

### **1.1.9.2 Refine**

This tool is used to increase the thickness of the balanced mesh generated automatically by the program. Using the dialog box the user can easily define where the mesh should be thicker. Because of numerical reasons it is needed to refine the mesh around the effects, which are in a point or along a line. These effects are for example point and line supports and loads, the places where there is a drastically change in the value of a surface load or the borders of two regions which have different material. It can be useful to refine the mesh along the free edges of the structure too.

The **Refine** function basically consists of two phases. In the first phase the user selects all the elements, which are to be divided. The second phase automatically splits the selected elements in the suitable way. In this second phase the program uses the principles publicised by Dr. István Kirchner in [11]. The dialog box makes the selection of the elements comfortable for the user.

### **1.1.9.3 Optimal rebuild**

This option rebuilds the mesh according to the global optimum. The nodes are not moved during the process. In the first phase of the process the program builds a triangle mesh using the principles of Delaunay triangulation technique based on the Voronoi domains. The second phase converts these triangles to quadrates corresponding to the global optimum for the selected regions. During the converting process the program uses the unique function, which is capable of creating the global optimum of the mesh. This involves the solving of a linear programming problem known in the mathematics as assignment problem. Our mathematicians have developed a new procedure to find the optimum for the linear programming problem. This problem is similar to the distribution method procedure.

### 1.1.9.4 Smooth

This option calculates the optimal coordinates for the corner nodes of the elements. The optimization of the mesh is based on Dr. István Kirchner's new procedure, which was published in [10]. This procedure places the nodes of the triangle elements in such a way, that the area of the triangles will be balanced. In achieving the most balanced area of the triangles an iteration technique is used.

## 1.1.10 Load group calculations

The user can define a number of load groups, which can be assigned as permanent, stress, temporary, seismic or accidental. Every load group contains one or more earlier defined load cases. Depending on the active code, different partial safety factors could be defined. The program will then automatically combine and calculate every possible load combination in order to find the most unfavourable load position for the variable loads.

Load groups defined as permanent will be present in all load combinations and if a load group contains more than one load case they will never be simultaneously present.

**Note:** As the calculation requires the principle of superposition when load groups are used, it is not possible to use the option **Consider cracking** as this requires a non-linear calculation.

The calculation method varies from standard to standard (the Code independent standard doesn't support load group calculations):

### 1.1.10.1 EuroCode (EC2)

Considering all defined load groups the load combinations will be created in the following way:

#### 1.1.10.1.1 Ultimate limit state

Design situations with only one variable action  $Q_{ki}$

$$s_d = \begin{cases} \sum \gamma G_K + \gamma_Q Q_{k,i} \\ \sum \xi \gamma G_K + \gamma_Q Q_{k,i} \end{cases}$$

Design situations with two or more variable actions  $Q_{ki}$

$$S_d = \begin{cases} \Sigma \gamma G_K + \gamma_Q Q_{k,i} \\ \Sigma \xi \gamma G_K + \gamma_Q \Psi Q_{k,i} \end{cases}$$

### 1.1.10.1.2 Serviceability limit state

Design situations with only one variable action

$Q_{k,i}$

$$S_d = \Sigma G_K + Q_{k,i}$$

Design situations with two or more variable actions

$Q_{k,i}$

$$S_d = \Sigma G_K + \Psi \Sigma Q_{k,i}$$

In this state the deformations and crack widths will be calculated.

In the example below the way of producing load combinations is exemplified for a plate but the method used applies also for walls.

#### Example:

A plate with four parts:

The load case **StruDL\_P r5** and **SoilDL\_P** acts on the entire plate while the variable loads **Q1\_T** and **Q2\_T** acts on the respective parts of the plate.

We set the *Combination method* to “*EC06.10.a,b*”.

We define the first two load groups with the name **G-Struct** and **G-Soil**. It will contain the load case **StruDL\_P** and **SoilDL\_P**, which are defined as *permanent* with favourable safety factor 1.00, unfavourable safety factor set to 1,35 and Xi factor to 0.9. Then we define two load groups **LG1** and **LG2** where we put load cases **Q1\_T** and **Q2\_T** respectively. These groups are all defined as *temporary* with the safety factor set to 1,5, the same time factor (Psi 0) to 0,5 and the other factors (Psi 1 and Psi 2) are 0.0.

The program will now create and analyse the following 27 load combinations:

1. StruDL\_P + SoilDL\_P,
2. StruDL\_P + SoilDL\_P + 1,50 · Q2\_T,



3.  $\text{StruDL\_P} + \text{SoilDL\_P} + 1,50 \cdot \text{Q1\_T}$ ,
4.  $\text{StruDL\_P} + \text{SoilDL\_P} + 1,50 \cdot 0,50 \cdot \text{Q1\_T} + 1,50 \cdot 0,50 \cdot \text{Q2\_T}$
5.  $\text{StruDL\_P} + 1,35 \cdot \text{SoilDL\_P} + 1,50 \cdot 0,50 \cdot \text{Q1\_T} + 1,50 \cdot 0,50 \cdot \text{Q2\_T}$
6.  $1,35 \cdot \text{StruDL\_P} + \text{SoilDL\_P} + 1,50 \cdot 0,50 \cdot \text{Q1\_T} + 1,50 \cdot 0,50 \cdot \text{Q2\_T}$
7.  $1,35 \cdot \text{StruDL\_P} + 1,35 \cdot \text{SoilDL\_P} + 1,50 \cdot 0,50 \cdot \text{Q1\_T} + 1,50 \cdot 0,50 \cdot \text{Q2\_T}$
8.  $0,90 \cdot \text{StruDL\_P} + 0,90 \cdot \text{SoilDL\_P}$
9.  $0,90 \cdot \text{StruDL\_P} + 0,90 \cdot \text{SoilDL\_P} + 1,50 \cdot \text{Q2\_T}$
10.  $0,90 \cdot \text{StruDL\_P} + 0,90 \cdot \text{SoilDL\_P} + 1,50 \cdot \text{Q1\_T}$
11.  $0,90 \cdot \text{StruDL\_P} + 0,90 \cdot \text{SoilDL\_P} + 1,50 \cdot \text{Q1\_T} + 1,50 \cdot 0,50 \cdot \text{Q2\_T}$
12.  $0,90 \cdot \text{StruDL\_P} + 0,90 \cdot \text{SoilDL\_P} + 1,50 \cdot 0,50 \cdot \text{Q1\_T} + 1,50 \cdot \text{Q2\_T}$
13.  $0,90 \cdot \text{StruDL\_P} + 0,90 \cdot 1,35 \cdot \text{SoilDL\_P}$
14.  $0,90 \cdot \text{StruDL\_P} + 0,90 \cdot 1,35 \cdot \text{SoilDL\_P} + 1,50 \cdot \text{Q2\_T}$
15.  $0,90 \cdot \text{StruDL\_P} + 0,90 \cdot 1,35 \cdot \text{SoilDL\_P} + 1,50 \cdot \text{Q1\_T}$
16.  $0,90 \cdot \text{StruDL\_P} + 0,90 \cdot 1,35 \cdot \text{SoilDL\_P} + 1,50 \cdot \text{Q1\_T} + 1,50 \cdot 0,50 \cdot \text{Q2\_T}$
17.  $0,90 \cdot \text{StruDL\_P} + 0,90 \cdot 1,35 \cdot \text{SoilDL\_P} + 1,50 \cdot 0,50 \cdot \text{Q1\_T} + 1,50 \cdot \text{Q2\_T}$
18.  $0,90 \cdot 1,35 \cdot \text{StruDL\_P} + 0,90 \cdot \text{SoilDL\_P}$
19.  $0,90 \cdot 1,35 \cdot \text{StruDL\_P} + 0,90 \cdot \text{SoilDL\_P} + 1,50 \cdot \text{Q2\_T}$
20.  $0,90 \cdot 1,35 \cdot \text{StruDL\_P} + 0,90 \cdot \text{SoilDL\_P} + 1,50 \cdot \text{Q1\_T}$
21.  $0,90 \cdot 1,35 \cdot \text{StruDL\_P} + 0,90 \cdot \text{SoilDL\_P} + 1,50 \cdot \text{Q1\_T} + 1,50 \cdot 0,50 \cdot \text{Q2\_T}$
22.  $0,90 \cdot 1,35 \cdot \text{StruDL\_P} + 0,90 \cdot \text{SoilDL\_P} + 1,50 \cdot 0,50 \cdot \text{Q1\_T} + 1,50 \cdot \text{Q2\_T}$
23.  $0,90 \cdot 1,35 \cdot \text{StruDL\_P} + 0,90 \cdot 1,35 \cdot \text{SoilDL\_P}$
24.  $0,90 \cdot 1,35 \cdot \text{StruDL\_P} + 0,90 \cdot 1,35 \cdot \text{SoilDL\_P} + 1,50 \cdot \text{Q2\_T}$
25.  $0,90 \cdot 1,35 \cdot \text{StruDL\_P} + 0,90 \cdot 1,35 \cdot \text{SoilDL\_P} + 1,50 \cdot \text{Q1\_T}$
26.  $0,90 \cdot 1,35 \cdot \text{StruDL\_P} + 0,90 \cdot 1,35 \cdot \text{SoilDL\_P} + 1,50 \cdot \text{Q1\_T} + 1,50 \cdot 0,50 \cdot \text{Q2\_T}$
27.  $0,90 \cdot 1,35 \cdot \text{StruDL\_P} + 0,90 \cdot 1,35 \cdot \text{SoilDL\_P} + 1,50 \cdot 0,50 \cdot \text{Q1\_T} + 1,50 \cdot \text{Q2\_T}$



## 2 Design calculations

### 2.1 Basics

**FEM-Design** performs design calculations for reinforced concrete-, steel- and timber structures according to Eurocode.

### 2.2 Concrete Design

The following design considers EC2 (standard) and the National Annex (NA) for Denmark, Finland, Germany, Hungary, Norway, Sweden and United Kingdom.

#### 2.2.1 Design forces

The design forces are the forces that the reinforcements should be designed for in the reinforcement directions. The term design forces have meaning only in surface structures like plate, wall or 3D plate. In beam structures the design forces are equivalent to the internal forces. The necessary reinforcement calculations are based on the design forces.

The way of calculating the design forces is common in all modules and in all standards.

In **FEM-Design** the design forces calculation is based on the mechanism of optimal reinforcement calculation for skew reinforcements made by M.P. Nielsen, Wood-Armer and Dr. Ferenc Németh, see [2]. The following description will show the way of calculation for moments but the way of the calculation is the same for normal forces too. Just substitute the **m** signs with **n** and you will have the calculation for normal forces.

For the calculation of the design forces we have given:

- $\xi, \eta$  reinforcement directions,
- $\alpha, \beta$  angle of global **x** direction and the  $\xi, \eta$  reinforcement directions,

- $m_x, m_y, m_{xy}$  internal forces.

The results will be the design moments:

- $\bar{m}_\xi, \bar{m}_\eta$

In the first step we are taking a  $\xi$ - $\theta$  coordinate system and transform the internal forces into this system:

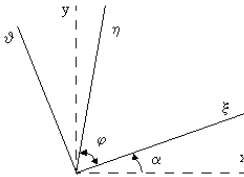
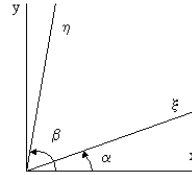

$$m_\xi = \frac{m_x + m_y}{2} + \frac{m_x - m_y}{2} \cos 2\alpha + m_{xy} \sin 2\alpha$$

$$m_\theta = \frac{m_x + m_y}{2} - \frac{m_x - m_y}{2} \cos 2\alpha - m_{xy} \sin 2\alpha$$

$$m_\xi = -\frac{m_x - m_y}{2} \sin 2\alpha + m_{xy} \cos 2\alpha$$

Now the design forces will be chosen from four basic cases called **a)**, **b)**,  $\xi$ ) and  $\eta$ ). The possible design moment pairs of the cases:

**a)** case:

$$\bar{m}_\xi = m_\xi - m_\theta \frac{\cos \varphi}{1 + \cos \varphi} + m_{\xi\theta} \frac{1 - 2\cos \varphi}{\sin \varphi}$$

$$\bar{m}_\eta = m_\theta \frac{1}{1 + \cos \varphi} + m_{\xi\theta} \frac{1}{\sin \varphi}$$

**b)** case:

$$\bar{m}_\xi = m_\xi + m_\theta \frac{\cos \varphi}{1 + \cos \varphi} - m_{\xi\theta} \frac{1 + 2\cos \varphi}{\sin \varphi}$$

$$\bar{m}_\eta = m_\theta \frac{1}{1 - \cos \varphi} - m_{\xi\theta} \frac{1}{\sin \varphi}$$

$\xi$ ) case: =  $-\frac{\xi\theta}{2}$

$$\bar{m}_\xi = m_\xi - \frac{m_{\xi\theta}^2}{m_\theta}$$

$$\bar{m}_\eta = 0$$

$\eta$ ) case:

$$\bar{m}_\xi = 0$$

$$\bar{m}_\eta = \frac{m_\xi m_\theta - m_{\xi\theta}^2}{m_\xi(\sin\varphi)^2 + m_\theta(\cos\varphi)^2 - m_{\xi\theta}\sin 2\varphi}$$

From the four cases the one is invalid where:

- the signs are different:  $\mathbf{m}_\xi * \mathbf{m}_\eta < 0$
- the crack tensor invariant is less than the internal forces invariant:

$$m^* = \bar{m}_\xi + \bar{m}_\eta < m_x + m_y = m_1 + m_2$$

$$m^{*'} = \bar{m}'_\xi + \bar{m}'_\eta < m_x + m_y = m_1 + m_2$$

The valid positive pair will be the design moment for bottom reinforcement; the valid negative pair will be the design moments for the top reinforcement (positive means positive and zero values; negative means negative and zero values).

So the result will be four values in a certain point: two moment values for each reinforcement directions. It can sound strange that the reinforcements are used for both positive and negative moment in one direction at the same time, but if we are looking at a plate where the  $\mathbf{m}_x$  is positive and the  $\mathbf{m}_y$  is negative and the reinforcements have an angle of 45 degree to the  $\mathbf{x}$  direction we could imagine that the bottom reinforcement bars make equilibrium to the  $\mathbf{m}_x$  and the top reinforcement bars make equilibrium to the  $\mathbf{m}_y$ . So a certain reinforcement direction takes positive and negative loads at the same time.

## 2.2.2 Shrinkage as load action

In the **Plate** and **3D Structure** modules the shrinkage behaviour of reinforced concrete slabs can be taken into consideration as load action. The program add this movement effect (specific rotation) calculated from the formulas written below to the structure as invisible load (one load case must be defined as **Shrinkage** type, see **User's Guide** [1]).

**Note:** The shrinkage effect has to be used together with applied reinforcement.

The effect of the shrinkage for the surface reinforcement bars in one direction (here **X**) (it is also valid in other bar directions):

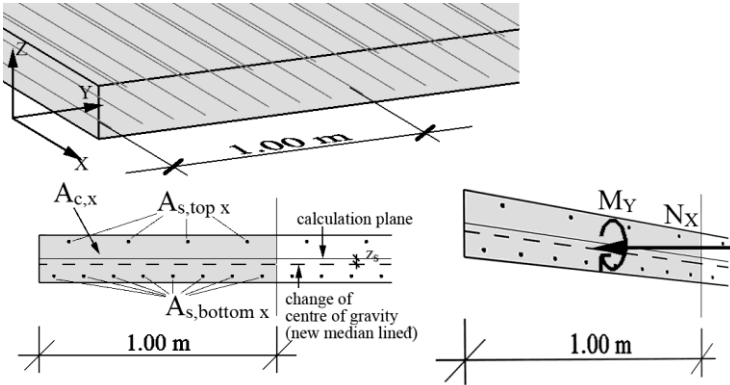

The specific normal force causing the given shrinkage value ( $\epsilon_{cs}$  [‰] at concrete materials) in the concrete zone of the section is (here in **X** direction):

$$N_X = E_c A_c \epsilon_{cs} \text{ [kN/m]}$$

The position change of centre of gravity considering reinforcement bars (here **X**-direction; see dashed line):

$$z_s = \frac{n S_s}{A_c + n A_s}$$

where:  $n = E_s / E_c$  and  $S_s$  is the static moment of (here) **X**-directional bars around the **Y** axis of the calculation plane.

The moment around the **Y** axis of the calculation plane from  $N_X$  because of the position change of centre of gravity:

$$M_Y = N_X z_s$$

The specific rotation (curvature) from  $M_Y$  for 1 meter wide section:

$$\kappa_Y = \frac{M_Y}{E_c I_Y}$$

where:  $I_Y = I_{c,Y} + n I_{s,Y} - z_s^2 (A_c + n A_s)$

## 2.2.3 Design calculations for surface structures

### 2.2.3.1 Ultimate limit state

#### Main reinforcement

The design of the slab is performed with respect to the design moments described in 2.2.1 above.

In order to minimize cracking in the slab a good way is to reinforce according to the elastic moments which normally also leads to good reinforcement economy.

The required bending reinforcement is designed according to EC2 3.1.7 where a rectangular stress distribution as shown below has been assumed.

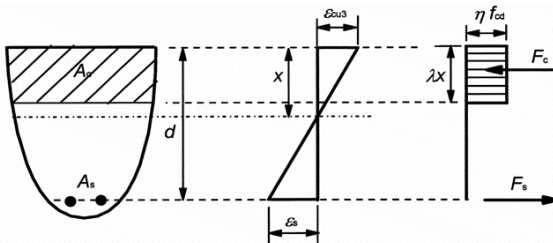

**Figure 3.5: Rectangular stress distribution**

$$\lambda = 0,8 \quad \text{for } f_{ck} \leq 50 \text{ MPa}$$

$$\lambda = 0,8 - (f_{ck} - 50)/400 \quad \text{for } 50 < f_{ck} \leq 90 \text{ MPa}$$

and:

$$\eta = 1,0 \quad \text{for } f_{ck} \leq 50 \text{ MPa}$$

$$\eta = 1,0 - (f_{ck} - 50)/200 \quad \text{for } 50 < f_{ck} \leq 90 \text{ MPa}$$

If the current moment is larger than the moment representing balanced design, compression reinforcement will be provided if allowed by the user otherwise an error message will be displayed. If the spacing regulations for the reinforcement are exceeded before adequate moment capacity can be reached a warning message will be displayed.

Note, that the required bending reinforcement is at design level primary not af-

ected of the presence of user defined reinforcement. However, when user defined applied reinforcement is selected the stiffness will be effected, which in most cases will influence the moment distribution and thus secondary the required bending reinforcement.

### 2.2.3.2 Shear capacity

The shear capacity is calculated according to EC2 6.2.2 and 6.2.3 considering applied bending reinforcement when the option **Checking** has been selected, otherwise the required bending reinforcement according to ch. 2.2.3.1.1. The design criteria for the shear capacity is:

$$V_{Sd} < V_{Rd1}$$

where:  $V_{Sd}$  is the design shear force;

$$V_{Sd} = Q, \text{ which is calculated as } Q = (T_x^2 + T_y^2)^{0.5}$$

$V_{Rd}$  is the shear capacity.

If the section in which the shear force is acting has an angle with respect to the reinforcement directions the shear capacity is calculated as:

$$V_{Rd} = (V_{Rd,x}^2 + V_{Rd,y}^2)^{1/2}$$

NAD Germany

Values for  $\tau_{Rd}$ :

<b>Grundwerte der Schubspannung <math>\tau_{Rd}</math></b>									
(DAfStb-Ri., Tab. R4 [5.10]; die in EC2, Tab 4.8 angegebenen Werte $\tau_{Rd}$ liegen auf der unsicheren Seite!)									
Betonfestigkeitsklasse C	12/15	16/20	20/25	25/30	30/37	35/45	40/50	45/55	50/60
$\tau_{Rd}$ in N/mm <sup>2</sup>	0,20	0,22	0,24	0,26	0,28	0,30	0,31	0,32	0,33

For German qualities B15-B55 the following applies:

$$f_{ctk0.05} = 0,25 \beta_{WN}^{2/3}$$

As shear check result is displayed missing capacity  $V_{Sd} - V_{Rd1} > 0$ . When the option **Shear check** has been selected a message is displayed at calculation if the shear capacity is not large enough.



### 2.2.3.3 Punching

The punching capacity is calculated according to EC2 6.4.3 - 6.4.5.

#### 2.2.3.3.1 Checking

##### Punching without shear reinforcement

A concrete compression check on  $\mathbf{u}_0$  is made according to 6.4.5 (6.53).

A concrete shear check on  $\mathbf{u}_1$  is made for a capacity calculated according to 6.4.4 (6.47).

##### Punching with shear reinforcement

A concrete compression check on  $\mathbf{u}_0$  is made according to 6.4.5 (6.53).

Reinforcement is calculated with regard to critical perimeters  $\mathbf{u}_1, \mathbf{u}_2, \dots, \mathbf{u}_{n\text{Reinf}}$  according to 6.4.5 (6.52).

( $\mathbf{u}_i$  are control perimeters above the reinforced region, distance between them is "Perimeter distance", defined in the calculation parameter).

A concrete shear check on  $\mathbf{u}_{\text{out}}$  is made for a capacity calculated according to 6.4.4 (6.47)

( $\mathbf{u}_{\text{out}}$  is either the first perimeter that does not need reinforcement, or if it is not found, the perimeter that is  $\mathbf{k d}_{\text{eff}}$  distance from the outer perimeter of the reinforcement).

#### Warnings

A warning message is shown, if reinforcement does not comply with the detailing rules in 9.4.3.

#### 2.2.3.3.2 Design

1. Check, if reinforcement is needed at all,
2. If reinforcement is needed, it is designed to satisfy the detailing rules in 9.4.3, if possible,
3. Design fails and a warning message is displayed if,  
 $\mathbf{u}_{\text{out}}$  is not found within  $\mathbf{6 d}_{\text{eff}}$  distance from the column perimeter.

### Comments, limitations

- openings are not considered when control perimeters are generated.
- the position of the column relative to the plate is considered only in the generation of control perimeter. It means, (user or program defined) reinforcement may be partly out of the plate, but it won't affect the calculation.
- If "Calculate  $\beta$  automatically" is set in the calculation parameter,  $\beta$  is calculated according to equation 6.4.3 (6.39).

### 2.2.3.4 Serviceability limit state

#### Method of solution

The program performs crack- and deflection control for all load combinations according to EC2 7.3 and 7.4. Two limiting conditions are assumed to exist for the calculations: **Stadium I** (the uncracked condition) and **Stadium II** (the fully cracked condition).

#### Stadium I Uncracked condition

If the user does not activate the option **Cracked section analysis** is, the calculation will be performed with respect to the total stiffness of the slab.

#### Stadium II Fully cracked condition

If the option **Cracked section analysis**, is activated the program will consider the decrease in slab stiffness on behalf of cracking. This means an iterative calculation where the slab in the beginning is assumed to be uncracked when the section forces are calculated. Sections which are not loaded above the level which would cause the tensile strength of the concrete to be exceeded will be considered to be uncracked (**Stadium I**). Sections which are expected to crack will behave in a manner intermediate between the uncracked and fully cracked conditions and an adequate prediction of behaviour used in the program is shown below.

The stiffness calculation is performed considering the required or the applied reinforcement depending on what option has been selected. If applied reinforcement has been selected this is used in all load combinations. If applied reinforcement is not present or not selected the required reinforcement is used

instead. In the latter case the required reinforcement in every element is calcula-

ted as the maximum value from all load combinations, which means that all calculations of serviceability limit values are performed with the same reinforcement.

In the next step a new calculation based on the new stiffness distribution is performed and so on. When the deflection values resulting from two calculations does not differ more than a defined percentage of the first one or the maximal number of allowed calculations has been reached the calculation is stopped.

### Crack width

Crack width is according to EC2 7.3.4 calculated as:

$$w_k = S_{r,max} (\epsilon_{sm} - \epsilon_{cm}) \quad (1)$$

where:  $S_{r,max}$  is the maximum crack spacing,

$\epsilon_{sm}$  is the mean strain in the reinforcement under the relevant combination of loads, including the effect of imposed deformations and taking into account the effects of tension stiffening. Only the additional tensile strain beyond the state of zero strain of the concrete at the same level is considered,

$\epsilon_{cm}$  is the mean strain in the concrete between cracks.

$\epsilon_{sm} - \epsilon_{cm}$  may be calculated from the expression:

$$\epsilon_{sm} - \epsilon_{cm} = \frac{\sigma_s - k_t \frac{f_{ct,eff}}{\rho_{p,eff}} (1 + \alpha_e \rho_{p,eff})}{E_s} \geq 0,6 \frac{\sigma_s}{E_s}$$

where:  $\sigma_s$  is the stress in the tension reinforcement assuming a cracked section. For pretensioned members,  $\sigma_s$  may be replaced by  $\Delta\sigma_p$  the stress variation in prestressing tendons from the state of zero strain of the concrete at the same level,

$\alpha_e$  is the ratio  $E_s / E_{cm}$

$A_p$  and  $A_{c,eff}$  are as defined in 7.3.2 (3),

$\xi_I$  according to Expression (7.5),

$k_t$  is a factor dependent on the duration of the load

$k_t = 0,6$  for short term loading

$k_t = 0,4$  for long term loading.

For long term loads ( $k_t = 0,4$ ):

$A_p' = 0,0$  (pre or post-tensioned tendons)

$A_{c,eff}$ :

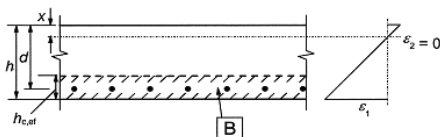

**[B]** - effective tension area,  $A_{c,eff}$

**Slab**

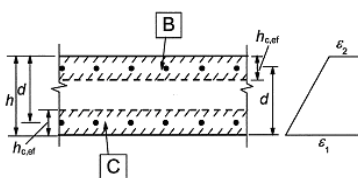

**[B]** - effective tension area for upper surface,  $A_{ct,eff}$

**[C]** - effective tension area for lower surface,  $A_{cb,eff}$

**Member in tension**

$$h_{cef} = \min (2,5 * (h - d), (h - x) / 3, h / 2)$$

$$s_{r,max} = k_3 c + k_1 k_2 k_4 \phi / \rho_{p,eff}$$

where:  $\phi$  is the bar diameter. Where a mixture of bar diameters is used in a section, an equivalent diameter,  $\phi_{eq}$ , should be used. For a section with  $n_1$  bars of diameter  $\phi_1$  and  $n_2$  bars of diameter  $\phi_2$ , the following expression should be used,

$$\phi_{eq} = \frac{n_1 \phi_1^2 + n_2 \phi_2^2}{n_1 \phi_1 + n_2 \phi_2}$$

$c$  is the cover to the longitudinal reinforcement,

$k_1$  is a coefficient which takes account of the bond properties of the bonded reinforcement:

$k_1 = 0,8$  for high bond bars,

$k_1 = 1,6$  for bars with an effectively plain surface (e.g. prestressing tendons),

$k_2$  is a coefficient which takes account of the distribution of strain:

$k_2 = 0,5$  for bending,

$k_2 = 1,0$  for pure tension,  
 $k_2 = (\varepsilon_1 + \varepsilon_2) / 2\varepsilon_1$

where  $\varepsilon_1$  is the greater and  $\varepsilon_2$  is the lesser tensile strain at the boundaries of the section considered, assessed on the basis of a cracked section.

Recommended values of  $k_3 = 3,4$  and  $k_4 = 0,425$  are used.

### Maximum crack spacing:

$$s_{r,max} = 1,3 (h - x)$$

### Equivalent quantities perpendicular to crack direction:

- **Reinforcement area:**

$$A = A_\xi \cos^2(\alpha - \xi) + A_\eta \cos^2(\alpha - \eta)$$

- **Number of bars:**

$$n_\xi = \frac{\cos(\alpha - \xi)A_\xi}{(\Pi\varphi^2\xi)/4}$$

$$n_\eta = \frac{\cos(\alpha - \eta)A_\eta}{\Pi\varphi^2\eta/4}$$

- **Diameter:**

$$\varphi = \frac{\cos(\alpha - \xi)n_\xi\varphi^2\xi + \cos(\alpha - \eta)n_\eta\varphi^2\eta}{\cos(\alpha - \xi)n_\xi\varphi\xi + \cos(\alpha - \eta)n_\eta\varphi\eta}$$

### Deflections

The calculations is performed according to EC2 7.4.3.

### Stadium I Uncracked condition

Load depended curvature is calculated as:

$$1 / r_f = M / E_{c,ef} I_1$$

where:  $\mathbf{M}$  is current moment,

$\mathbf{I}_1$  is Moment of Inertia in **Stadium I**,

$\mathbf{E}_{c,ef}$  is the modulus of elasticity with respect to creep.

The modulus of elasticity is calculated as:

$$E_{c,eff} = E_{cm} / (1 + \varphi)$$

where  $\varphi$  is the creep coefficient.

Curvature with respect to shrinkage is considered according to 2.2.2 above.

### **Stadium II Fully cracked condition**

Load depended curvature is calculated as:

$$1 / r_f = M / E_{c,ef} I_2$$

where:  $\mathbf{E}_{c,ef}$  is the modulus of elasticity as shown above,

$\mathbf{I}_2$  is the moment of Inertia in **Stadium II**,

$\mathbf{M}$  is current moment.

Curvature with respect to shrinkage is considered according to 2.2.2 above.

Sections which are expected to crack will behave in a manner intermediate between the uncracked and fully cracked conditions and an adequate prediction of this behaviour is given by:

$$\alpha = \zeta \alpha_{II} + (1 - \zeta) \alpha_I$$

where:  $\alpha$  is in this case the curvature calculated for the uncracked and fully cracked conditions,

$\zeta$  is a distribution coefficient given by  $\zeta = 1 - \beta (\sigma_{sr} / \sigma_s)^2$

$\zeta$  is zero for uncracked sections,

$\beta$  is a coefficient taking account of the influence of the duration of the loading or of repeated loading on the average strain,

$\sigma_s$  is the stress in the tension steel calculated on the basis of a cracked section,

$\sigma_{sr}$  is the stress in the tension steel calculated on the basis of a cracked section under the loading which will just cause cracking at the section being considered.

**Note** that stresses and moment of inertia are calculated with applied reinforcement if it is selected, otherwise with required reinforcement.

## 2.2.4 Design calculations for bar structures

### 2.2.4.1 Material properties

#### Concrete

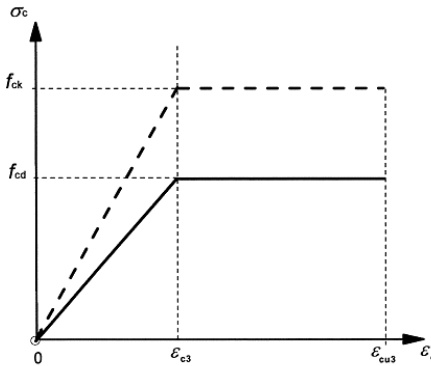
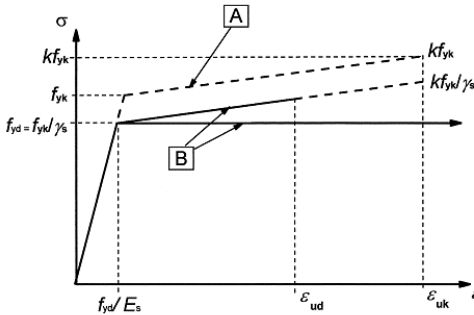

Figure 3.4: Bi-linear stress-strain relation.

- **Ultimate limit states:**  
Continuous line is used.
- **Servicability limit states:**  
Stage II is used (dashed line, without horizontal section).

# Steel



- **Ultimate limit states:**  
B graph with horizontal line is used.
- **Servicibility limit states:**  
The same as ultimate but without safety factor.

## 2.2.4.2 Longitudinal reinforcement

### Analysis of second order effects with axial load

According to EC2 5.8.

For calculation of 2<sup>nd</sup> order effect **Nominal curvature** method (5.8.8) is used.

- If there is no compression force in the section the eccentricity is equal to **0,0**.
- Buckling lengths  $l_{0x}$  and  $l_{0y}$  are specified by the user.
- Curvature:

$$1 / r = k_r k_\phi 1 / r_0$$

where:  $k_r$  is a correction factor depending on axial load,

$k_\phi$  is a factor for taking account of creep,

$$1 / r_0 = \varepsilon_{yd} / (0,45 d),$$

$d$  is the effective depth,



$$d = (h / 2) + i_s$$

where  $i_s$  is the radius of gyration of the total reinforcement area.  
 $k_r = (n_u - n) / (n_u - n_{bal}) \leq 1$

where:

$n = N_{Ed} / (A_c f_{cd})$ , relative axial force,

$N_{Ed}$  is the design value of axial force,

$n_u = 1 + \omega$ ,

$n_{bal}$  is the value of  $n$  at maximum moment resistance; the value 0,4 is used,

$\omega = A_s f_{yd} / (A_c f_{cd})$ ,

$A_s$  is the total area of reinforcement,

$A_c$  is the area of concrete cross section,

$k_\phi = 1 + \beta \phi_{ef} \geq 1$

where:

$\phi_{ef}$  is effective creep ratio, defined by the user,

$\beta = 0,35 + f_{ck} / 200 - \lambda / 150$ ,

$\lambda$  is the slenderness ratio.

- 2<sup>nd</sup> order effect is ignored, if:

$$\lambda \leq \lambda_{lim}$$

$$\lambda_{lim} = 20 A B C / \sqrt{n}$$

where:  $A = 1 / (1 + 0,2 \phi_{ef})$ ,

$B = \sqrt{1 + 2 \omega}$ ,

$C = 0,7$

$\phi_{ef}$  is effective creep ratio,

$\omega = A_s f_{yd} / (A_c f_{cd})$ , mechanical reinforcement ratio,

$A_s$  is the total area of longitudinal reinforcement,

$n = N_{Ed} / A_c f_{cd}$ , relative normal force,

$r_m = M_{01} / M_{02}$ , moment ratio,

$M_{01}$ ,  $M_{02}$  are the first order en moments  $|M_{02}| \geq |M_{01}|$ .

- Geometric imperfection (5.2 (7) a):

$$e_i = l_0 / 400$$

- The minimum of all eccentricities (1<sup>st</sup> order + imperfection + 2<sup>nd</sup> order

effect):  $\max(20,0; h / 30,0)$ .

- Imperfection and 2<sup>nd</sup> order effect considered in both directions.
- The eccentricity is calculated in four possible positions:
  - Stiff direction+, weak direction+
  - Stiff -, weak+
  - Stiff+, weak-
  - Stiff-, weak-

## Torsion

- Necessary longitudinal reinforcement area ( $A_{sl}$ ):  
 $T_{Ed}$  is the applied design torsion (see Figure 6.11):

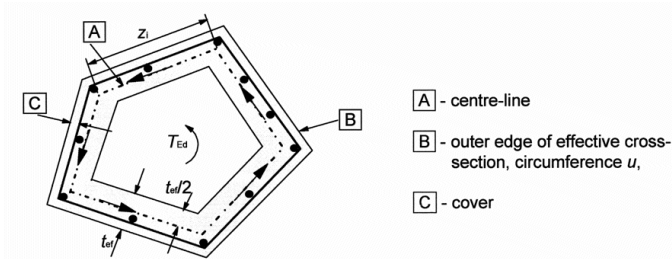

Figure 6.11: Notations and definitions

The required cross-sectional area of the longitudinal reinforcement for torsion  $\Sigma A_{sl}$  may be calculated from:

$$\frac{\Sigma A_{sl} f_{yd}}{u_k} = \frac{T_{Ed}}{2A_k} \cot \theta$$

where:  $u_k$  is the perimeter of the area  $A_k$ ,

$f_{yd}$  is the design yield stress of the longitudinal reinforcement  $A_{sl}$ ,

$\theta$  is the angle of compression struts,  $\theta = 45 \text{ deg}$ .

Considering torsion in calculation of longitudinal bars:

Calculation of torsional capacity by edges, considering all bars placed in  $t_{ef}$  strip. The minimum of capacities gives the torsional capacity of the section.

Utilization for torsion calculated for all bars placed in the strip one by one.

Area of these bars decreased in the calculation of axial effects ( $N$ ,  $M_y$ ,  $M_z$ ) in proportion of utilization (see formula below):

$$A' = A \left( 1 - \frac{T_{Ed}}{T_{Rd}} \right) \quad \text{where:}$$

$A$  is area of the bar,

$A'$  is decreased area used in calculation

## ULS checking

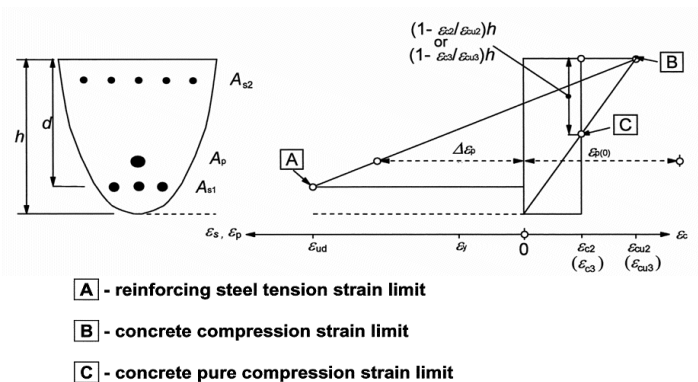

Figure 6.1: Possible strain distributions in the ultimate limit state

## SLS checking

Crack width calculated according to EC2 7.3.

- Crack width calculated as:

$$w_k = s_{r,max} (\epsilon_{sm} - \epsilon_{cm})$$

where:  $s_{r,max}$  is the maximum crack spacing,

$\varepsilon_{sm}$  is the mean strain in the reinforcement under the relevant combination of loads, including the effect of imposed deformations and taking into account the effects of tension stiffening. Only the additional tensile strain beyond the state of zero strain of the concrete at the same level is considered,

$\varepsilon_{cm}$  is the mean strain in the concrete between cracks.

$\varepsilon_{sm} - \varepsilon_{cm}$  may be calculated from the expression:

$$\varepsilon_{sm} - \varepsilon_{cm} = \frac{\sigma_s - k_t \frac{f_{ct,eff}}{\rho_{p,eff}} (1 + \alpha_e \rho_{p,eff})}{E_s} \geq 0,6 \frac{\sigma_s}{E_s}$$

where:  $\sigma_s$  is the tension reinforcement assuming a cracked section,

$\alpha_e$  is the ratio  $E_s / E_{cm}$

$\rho_{p,eff} = A_s / A_{c,eff}$ ,

$A_{c,eff}$  is calculated as below,

$k_t$  is a factor dependent on the duration of the load,

$k_t = 0,6$  for short term loading,

$k_t = 0,4$  for long term loading (always supposed by the program),

$A_{c,eff}$ :

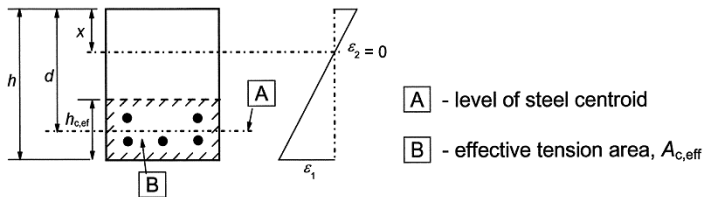

$$h_{c,ef} = \min (2,5 (h - d), (h - x) / 3, h / 2)$$

$$s_{r,max} = k_3 c + k_1 k_2 k_4 \varphi / \rho_{p,eff}$$

where:  $\varphi$  is the bar diameter. Where a mixture of bar diameters is used in a section, an equivalent diameter,  $\varphi_{eq}$ , should be used. For a section with  $n_1$  bars of diameter  $\varphi_1$  and  $n_2$  bars of diameter  $\varphi_2$ , the following expression should be used,

$$\varphi_{eq} = \frac{n_1 \varphi_1^2 + n_2 \varphi_2^2}{n_1 \varphi_1 + n_2 \varphi_2}$$

$c$  is the cover to the longitudinal reinforcement,

$k_1$  is a coefficient which takes account of the bond properties of

the bonded reinforcement:

$k_1 = 0,8$  for high bond bars,

$k_1 = 1,6$  for bars with an effectively plain surface (e.g. prestressing tendons),

$k_2$  is a coefficient which takes account of the distribution of strain:

$k_2 = 0,5$  for bending,

$k_2 = 1,0$  for pure tension

For cases of eccentric tension or for local areas, intermediate values of  $k_2$  should be used which may be calculated from the relation:

$$k_2 = (\varepsilon_1 + \varepsilon_2) / 2 \varepsilon_1,$$

where:  $\varepsilon_1$  is the greater and  $\varepsilon_2$  is the lesser tensile strain at the boundaries of the section considered, assessed on the basis of a cracked section.

Recommended values of  $k_3 = 3,4$  and  $k_4 = 0,425$  are used.

- Maximum crack spacing:

$$s_{r,max} = 1,3 (h - x)$$

## Space between bars

- **Minimum distance:**

The clear distance (horizontal and vertical) between individual parallel bars or horizontal layers of parallel bars should be not less than the maximum of  $k_1$  bar diameter,  $(d_g + k_2 \text{ mm})$  or 20 mm where  $d_g$  is the maximum size of aggregate.

- **Maximum distance:**

The longitudinal bars should be so arranged that there is at least one bar at each corner, the others being distributed uniformly around the inner periphery of the links, with a spacing not greater than 350 mm.

## Lengthening and anchorage

- **Because of shear effect (*shift rule*):**

$$a_r = 0,9 \max (h, b)$$

The code prescribes **d** instead of **h**, but the difference can be ignored.

- **Anchorage:**

$$f_{bd} = 2,25 \eta_1 \eta_2 f_{ctd}$$

where:  $f_{ctd}$  is design value of concrete tensile strength. Due to the increasing brittleness of higher strength concrete,  $f_{ctk, 0,05}$  should be limited here to the value for **C60/75**, unless it can be verified that the average bond strength increases above this limit,

$\eta_1$  is a coefficient related to the quality of the bond condition and the position of the bar during concreting:

$$\eta_1 = 0,7$$

$\eta_2$  is related to the bar diameter:

$$\eta_2 = 1,0 \text{ for } \varphi \leq 32 \text{ mm,}$$

$$\eta_2 = (132 - \varphi) / 100 \text{ for } \varphi > 32 \text{ mm}$$

$$l_{b,rqd} = (\varphi / 4) (\sigma_{sd} / f_{bd})$$

where:  $\sigma_{sd} = f_{yd}$  (fully utilized bar supposed),

$$l_{bd} = \alpha_1 \alpha_2 \alpha_3 \alpha_4 \alpha_5 l_{b,rqd} \geq l_{b,min},$$

$$\alpha_i = 1,0$$

$l_{b,min}$  is the minimum anchorage length if no other limitation is applied:

- for anchorages in tension:  
 $l_{b,min} > \max (0,3 l_{b,rqd}; 10 \varphi; 100 \text{ mm}),$
- for anchorage in compression:  
 $l_{b,min} > \max (0,6 l_{b,rqd}; 10 \varphi; 100 \text{ mm}),$   
Rule given for compression is used.

### 2.2.4.3 Stirrups

#### Shear

In Figure 6.5 below the following notations are shown:

$\alpha$  is the angle between shear reinforcement and beam axis perpendicular to the shear force (measured positive as shown in Figure 6.5),

$\theta$  is the angle between the concrete compression strut and the beam axis perpendicular to the shear force,

$F_{td}$  is the design value or the tensile force in the longitudinal reinforcement,

$F_{cd}$  is the design value of the concrete compression force in the direction of the longitudinal member axis,

$b_w$  is the minimum width between tension and compression chords,

$z$  is the inner lever arm, for a member with constant depth, corresponding to the bending moment in the element under consideration. In the shear analysis of reinforced concrete without axial force, the approximate value  $z = 0,9 d$  may normally be used.

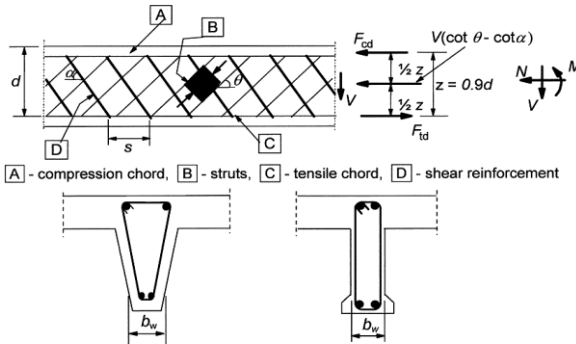

Figure 6.5: Truss model and notation for shear reinforced members

- **Member do not require shear reinforcement, if:**

The design value for the shear resistance  $V_{Rd,c}$  is given by:

$$V_{Rd,c} = [C_{Rd,c} k (100 \rho_l f_{ck})^{1/3} + k_1 \sigma_{cp}] b_w d \quad (6.2.a)$$

with a minimum of:

$$V_{Rd,c} = (v_{min} + k_1 \sigma_{cp}) b_w d \quad (6.2.b)$$

where:  $f_{ck}$  is in MPa

$$k = 1 + \sqrt{\frac{200}{d}} \leq 2.0 \quad \text{with } d \text{ in mm}$$

$$\rho_l = \frac{A_{sl}}{b_w d} \leq 0.02$$

$A_{sl}$  is the area of the tensile reinforcement, which extends:  
 $\geq (l_{bd} + d)$  beyond the section considered (see Figure 6.3),  
 $b_w$  is the smallest width of the cross-section in the tensile area [mm],

$$\sigma_{cp} = N_{Ed} / A_c < 0,2 f_{cd} \text{ [MPa]},$$

$N_{Ed}$  is the axial force in the cross-section due to loading or prestressing [in N] ( $N_{Ed} > 0$  for compression). The influence of imposed deformations on  $N_E$  may be ignored,

$A_c$  is the area of concrete cross section [mm<sup>2</sup>],

$V_{Rd,c}$  is [N]

The recommended value for  $C_{Rd,c}$  is **0,18** /  $\gamma_c$ , that for  $v_{min}$  is given by the expression below and that for  $k_1$  is **0,15**.

$$v_{min} = 0,035 k^{3/2} f_{ck}^{1/2}$$

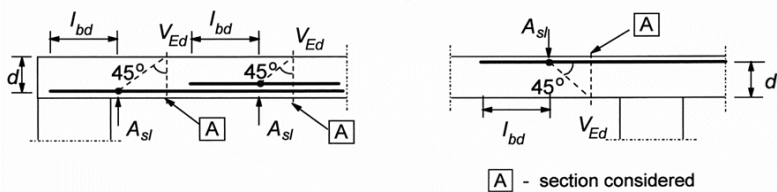

**Figure 6.3: Definition of  $A_{sl}$**

- **Upper limit of shear:**

$$V_{Rd,max} = \alpha_{cw} b_w z v_1 f_{cd} / (\cot\theta + \tan\theta) \quad (6.9)$$

where:  $A_{sw}$  is the cross-sectional area of the shear reinforcement,

$s$  is the spacing of the stirrups,

$f_{ywd}$  is the design yield strength of the shear reinforcement,

$v_1$  is a strength reduction factor for concrete cracked in shear,

$\alpha_{cw}$  is a coefficient taking account of the state of the stress in the compression chord.

The recommended value of  $v_1$  is  $v$  (see expression below).

The recommended value of  $\alpha_{cw}$  is as follows:

**1** for non-prestressed structures,



$$v = 0.6 \left[ 1 - \frac{f_{ck}}{250} \right]$$

$$\theta = 45 \text{ deg}$$

$$z = 0,9 d$$

- **Capacity of stirrups:**

$$V_{Rd,s} = \frac{A_{sw}}{s} z f_{ywd} \cot \theta$$

where:  $A_{sw}$  is the cross-sectional area of the shear reinforcement,

$s$  is the spacing of the stirrups,

$f_{ywd}$  is the design yield strength of the shear reinforcement.

## Torsion

$T_{Ed}$  is the applied design torsion (see Figure 6.11)

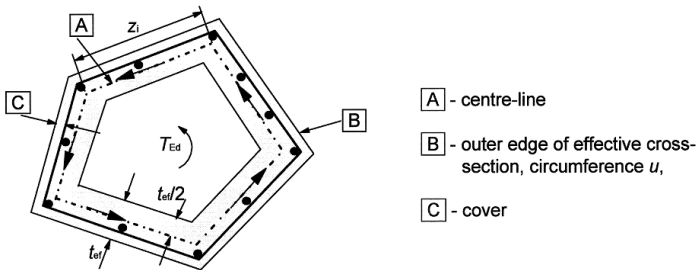

Figure 6.11: Notations and definitions used

$A_k$  is the area enclosed by the centre-lines of the connecting walls, including inner hollow areas,

$\tau_{t,i}$  is the torsional shear stress in wall  $i$ ,

$t_{ef,i}$  is the effective wall thickness. It may be taken as  $A/u$ , but should not be taken as less than twice the distance between edge and centre of the longitudinal reinforcement. For hollow sections the real thickness is an upper limit,

$A$  is the total area of the cross-section within the outer circumference, including inner hollow areas,

$u$  is the outer circumference of the cross-section,

$z_i$  is the side length of wall  $i$  defined by the distance between the intersection points with the adjacent walls,

$\theta = 45 \text{ deg}$ ,  
in all  
calculations.

- **Member do not require torsional reinforcement, if:** (6.29)  

$$T_{Rd,c} = f_{cd} t_{ef} 2 A_k \leq T_{Ed}$$

- **Upper limit of torsion:**  

$$T_{Rd,max} = 2 v \alpha_{cw} f_{cd} A_k t_{ef,i} \sin\theta \cos\theta$$
 (6.30)  
 where  $v$  and  $\alpha_{cw}$  are as above.

- **Force in stirrups:**  

$$T_{Rd,max} = 2v\alpha_{cw}f_{cd}A_k t_{ef,i} \sin\theta \cos\theta$$
  
 The shear force  $V_{Ed,i}$  in a wall  $i$  due to torsion is given by:  

$$V_{Ed,i} = \tau_{t,i} t_{ef,i} z_i$$
  
 $z_i$  is section height used to be able to sum with shear.

- **Capacity of stirrups:**  
 See **Shear**.

## Shear and torsion

- **Forces in stirrups:**  

$$V_{Ed} = V_{Ed(\text{shear})} / 2 + V_{Ed(\text{torsion})}$$
- **No stirrup required:**  

$$T_{Ed} / T_{Rd,c} + V_{Ed} / V_{Rd,c} \leq 1,0$$
 (6.31)
- **Upper limit of the effects:**  

$$T_{Ed} / T_{Rd,max} + V_{Ed} / V_{Rd,max} \leq 1,0$$
 (6.29)
- **Calculation is done in two directions  $y'$  and  $z'$  independently.**

## 2.3 Steel Design

### 2.3.1 General

The following design considers EC2 (standard) and the National Annex (NA) for Denmark, Finland, Germany, Hungary, Norway, Sweden and United Kingdom.

With the steel module arbitrary structures in space can be designed with regard to a 1<sup>th</sup> order or a 2<sup>nd</sup> order analysis.

In the **Code Check** all checks prescribed in the codes depending on section type, section class and acting section forces are displayed.

### 2.3.2 Limitations

#### 2.3.2.1 Torsion

Only uniform torsion (St Venant torsion) is considered in the present version. For thin walled open sections the effect of warping torsion (Vlasov torsion) could be important and must then be considered separately.

#### 2.3.2.2 Crushing of the web

Crushing of an unstiffened web due to a concentrated force is not checked in the present version.

### 2.3.3 Global analysis

#### 2.3.3.1 General

The design can be performed using either:

- 1<sup>th</sup> order analysis, using the initial geometry of the structure or,
- 2<sup>nd</sup> order analysis, taking into account the influence of the deformation of the structure.

### 2.3.3.1.1 Choise between a 1<sup>th</sup> order or a 2<sup>nd</sup> order analysis

For structures not sensitive to buckling in a sway mode a 1<sup>th</sup> order analysis is sufficient. The design for member stability should then be performed with non-sway buckling lengths.

In many cases it is easy to decide if a structure is sway or non-sway but in other cases it could be more difficult.

One way to estimate if the non-sway condition is fulfilled is described in EC3 part 1-1 with the following criterion:

$$\alpha_{cr} = F_{cr} / F_{Ed} > 10 \Rightarrow \text{Non-sway}$$

where:  $\alpha_{cr}$  is the critical parameter meaning the factor by which the design loading would have to be increased to cause elastic instability in a global mode,

$F_{Ed}$  is the design loading on the structure,

$F_{cr}$  is the elastic critical buckling load for global instability mode based on initial elastic stiffness.

An imperfection calculation in **FEM-Design** will display the critical parameters for the number of buckling shapes required by the user as shown below.

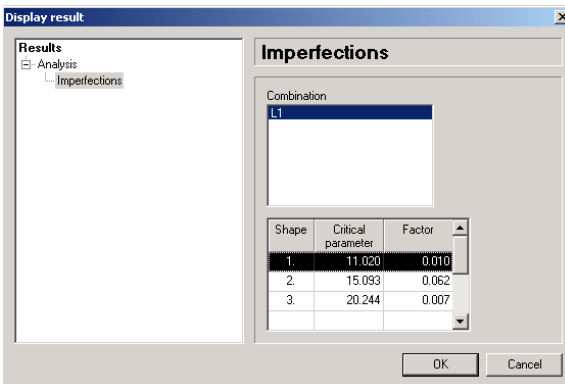

Critical parameter  $\alpha_{cr}$  displayed for the three first buckling shapes with regard to load combination L1.

As all critical parameters are  $> 10$  a 1<sup>th</sup> order analysis and a design with non-sway buckling lengths would be sufficient in this case.

If the criterion above is not fulfilled 2<sup>nd</sup> order effects must be considered but a 1<sup>th</sup> order analysis could still be used in most cases. This could be done either by amplifying the 1<sup>th</sup> order moments or by using sway-mode buckling lengths. In **FEM-Design** the latter method should be used.

A full 2<sup>nd</sup> order analysis can be used for steel design in all cases.

### 2.3.3.2 Structural stability

The calculations with regard to instability will be performed in different ways depending on the type of analysis.

#### 2.3.3.2.1 1<sup>th</sup> order theory

For a 1<sup>th</sup> order design the following apply:

Both the flexural, lateral torsional and torsional buckling are calculated depending on the slenderness with respect to reduction factors specified in the appropriate code. The reduced slenderness for flexural and torsional buckling may be computed as:

$$\lambda = [A f_y / N_{cr}]^{1/2}$$

The critical normal force for flexural buckling  $N_{cr}$  will in this case be calculated using appropriate buckling lengths defined by the user in both directions for all members.

The critical normal force  $N_{cr}$  for torsional buckling will be calculated according to support conditions defined by the user for all members.

The reduced slenderness for lateral torsional buckling may be computed as:

$$\lambda_{LT} = [W f_y / M_{cr}]^{1/2}$$

The critical moment  $M_{cr}$  will be calculated as buckling of the compressed flange with regard to a buckling length defined by the user.

### **Imperfections**

Initial bow imperfections may be neglected as these effects are included in the formulas for buckling resistance of the members.

For sway mode structures initial sway imperfections has to be considered. This could be done by changing the geometry before calculation or by defining systems of equivalent horizontal forces as described below.

#### **2.3.3.2.2 2<sup>nd</sup> order theory**

A 2<sup>nd</sup> order calculation produces the critical normal force  $N_{cr}$  for flexural buckling and a corresponding stability check is not required. The critical normal force  $N_{cr}$  for torsional buckling or the critical moment  $M_{cr}$  are not calculated since a basic finite element only contains the second order effects of the axial force and the effect of warping is neglected. The effect of the lateral torsional and torsional buckling will then have to be calculated as for 1<sup>th</sup> order above.

### **Imperfections**

For all structures initial local bow imperfections should be considered.

As the flexural buckling design is based on the 2<sup>nd</sup> order effects of the bending moments it is vital that there is a moment distribution in all members. By considering local bow imperfections this is ensured also for hinged members without lateral load.

For sway mode structures also initial sway imperfections has to be considered. This could be done in the conventional way by changing the geometry before calculation or by defining systems of equivalent horizontal forces as described in 2.3.3.3.1 below.

In **FEM-Design** both initial bow imperfections and initial sway imperfections are considered automatically by using an alternative method presented in EC3 1-1 as described below in 2.3.3.3.2. The user has to connect each load combination to one of the calculated buckling shapes and the program will then calculate imperfections with regard to this shape. It is up to the user to decide how many buckling shapes that has to be considered and to which load combinations these shapes should be connected to receive an adequate result. No design based on a 2<sup>nd</sup> order analysis for compressed members can be performed without con-

sidering imperfection for one of the available buckling shapes. Some examples describing this process are presented in the manual **Useful examples**.

**Note!** When performing a 2<sup>nd</sup> order calculation a division of the members in more than one finite element could strongly influence the result. See chapter 2.3.3.4 for more information.

### 2.3.3.3 Imperfections for global analysis of frames

The following imperfections should be taken into account:

1. Global imperfections for the structure as a whole.
2. Local imperfections for individual members.

The assumed shape of global imperfections and local imperfections may be derived from the elastic buckling mode of a structure in the plane of buckling considered.

Both in and out of plane buckling including torsional buckling with symmetric and asymmetric buckling shapes should be taken into account in the most unfavourable direction and form.

For frames sensitive to buckling in a sway mode the effect of imperfections should be allowed for in frame analysis by means of an equivalent imperfection in the form of an initial sway imperfection and individual bow imperfections of members.

#### 2.3.3.3.1 Conventional method

- **Global initial sway imperfections**

This effect could be considered in two ways.

1. By changing the frame geometry before analysis with the slope  $\phi$  as shown below.

The slope  $\phi$  will be calculated according to the relevant code.

2. By defining a system of equivalent horizontal forces as shown below:

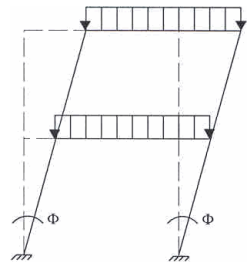

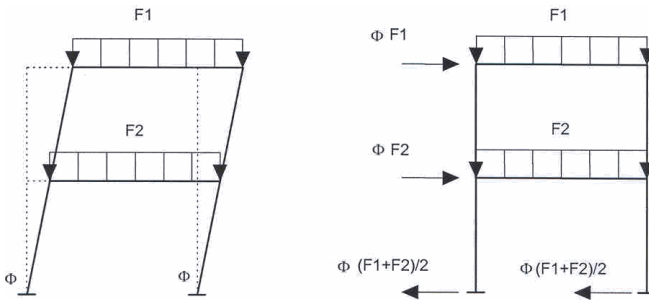

Where, in multi-storey beam and column building frames, equivalent forces are used they should be applied at each floor and roof level.

These initial sway imperfections should apply in all relevant horizontal directions, but need only be considered in one direction at a time.

The possible torsional effects on a structure caused by anti-symmetric sways at the two opposite faces, should also be considered.

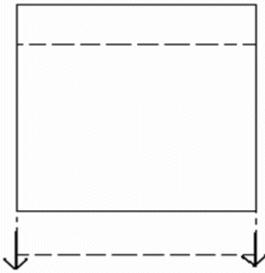

*Translational sway*

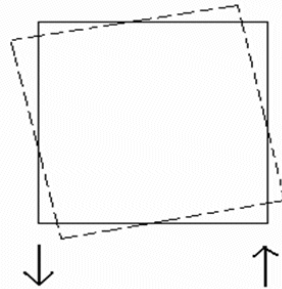

*Rotational sway*

- **Relative initial local bow imperfections of members for flexural buckling**

Equivalent horizontal forces introduced for each member as shown below could consider this effect.

The value  $e_0$  considering initial bow as well as residual stresses is calculated according to the relevant code.

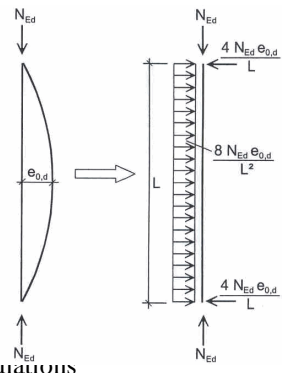

### 2.3.3.3.2 Alternative method



As an alternative to the methods described above for calculating imperfections the shape of the elastic critical buckling mode  $\eta_{cr}$  of the structure may be applied as a unique global and local imperfection according to EC3 1-1. This method is used in **FEM-Design** when a 2<sup>nd</sup> order analysis together with imperfection for one of the available buckling shapes is chosen.

The amplitude of this imperfection may be determined from:

$$\eta_{init} = e_{0d} \frac{N_{Rk}}{EI \eta_{cr,max}} \eta_{cr}$$

where:  $\eta_{init}$  imperfection,  
 $\eta_{cr}$  buckling shape.

$$e_{0d} = \frac{\alpha(\bar{\lambda} - 0.2) M_{Rk}}{\bar{\lambda}^2} \frac{1 - \frac{\chi \bar{\lambda}^2}{\gamma_{M1}}}{N_{Rk} (1 - \chi \bar{\lambda}^2)}$$

where:  $\bar{\lambda} = \sqrt{\frac{\alpha_{ult,k}}{\alpha_{cr}}}$  is the relative slenderness of the structure

$\alpha$  is the imperfection factor for the relevant buckling curve,

$\chi$  is reduction factor for the relevant buckling curve depending on the cross-section and the relevant code,

$M_{Rk}$  is the characteristic moment resistance of the critical cross-section,

$N_{Rk}$  is the characteristic resistance to axial force of the critical cross-section,

$EI \eta_{cr,max}$  is the bending moment due to  $\eta_{cr}$  at the critical cross section,

$$\alpha_{ult,k} = \min \left( \frac{f_y}{\sigma_{max}} \right)$$

where:  $\alpha_{max}$  is calculated from 1<sup>st</sup> order theory and  $\frac{f_y}{\sigma_{max}}$  to be calculated at each cross-section.

$\alpha_{ult,k}$  is the maximum force amplifier for the axial force configuration  $N_{Ed}$  in members to reach the characteristic resistance  $N_{Rk}$  of the most axially stressed cross section without taking buckling into account,

$\alpha_{cr}$  is the minimum force amplifier for the axial force configuration  $N_{Ed}$  in members to reach the elastic critical buckling.

To be able to perform a design based on a 2<sup>nd</sup> order analysis for compressed members imperfection for one of the available buckling shapes must be chosen by the user. It is important to decide which shapes that have to be considered for the current structure. Some examples are described in the manual **Useful examples**.

### 2.3.3.4 Division of members

When performing a 2<sup>nd</sup> order calculation it is sometimes important to divide the members into more finite elements to get an accurate result. Some advice about this will be found below.

#### Frame type structures

A first calculation without division will show the force distribution in the structure. All compressed members should then be divided into an even member of elements e.g. four. It is recommended only to divide members in compression but as in reality members can be in compression for one loadcase and in tension for another this is often not possible.

If tensioned members are divided this could result in negative critical factors but they do not represent physical valid shapes and should be ignored. See also the manual **Useful examples, Example 2**.

#### Truss type structures

To perform a global stability check the grid members should not be divided but if local buckling is of interest they should. See the manual **Useful examples, Example 3**.

## 2.3.4 EuroCode (EC3)

### 2.3.4.1 Classification of cross-sections

The classification is made according to EN 1993-1-1 5.5-5.6.

A section is classified in section class 1, 2, 3 or 4 depending on the slenderness of the section, see EN 1993-1-1 5.5.2. Class 1 - The section can reach full plastic yielding, with sufficient rotation capacity for a plastic analysis.

Class 2 - The section can reach full plastic yielding, but the rotation capacity is limited.

Class 3 - The section can reach the yield limit without buckling.

Class 4 - Local buckling will occur before the yield limit is reached.

In case of general cross-section the *line-topology* have to be determined to decide if the part is *internal* or *outstand*.

It can be decided based on the connections, see picture below.

Parts between two nodes are *internal*, all other *outstand*.

If different parts of a section belongs to different classes the highest class will be chosen for the section.

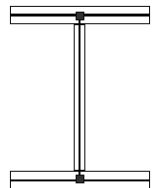

### 2.3.4.2 Axial force capacity

The capacity is calculated according to EN 1993-1-1 6.2.3-6.2.4.

#### 2.3.4.2.1 Tension force

The capacity is calculated as:

$$N_{t,Rd} = A f_y / \gamma_{M0}$$

where: **A** gross area,  
**f<sub>y</sub>** design strength,  
**γ<sub>M0</sub>** partial factor.

#### 2.3.4.2.2 Compression force

- **Section Class 1, 2 and 3**

The capacity is calculated as:

$$N_{b,Rd} = \chi A f_y / \gamma_{M1}$$

where  $\chi$  is the flexural buckling factor with regard to buckling around y-y axis and z-z axis respectively,  $\gamma_{M1}$  partial factor.

- **Buckling factor**

The buckling factor is calculated as:

$$\chi = 1 / (\Phi + (\Phi^2 - \lambda^2)^{0,5}) \leq 0,1$$

$$\Phi = 0,5 [1 + \alpha(\lambda - 0,2) + \lambda^2]$$

$\lambda$  is the slenderness calculated as:

$$\lambda = (A f_y / N_{cr})^{0,5}$$

$N_{cr}$  is the elastic critical load for the relevant buckling mode.

The imperfection factor  $\alpha$  is related to five groups according to the table below:

Group a<sub>0</sub>,  $\alpha = 0,13$ ; group a,  $\alpha = 0,21$ ; group b,  $\alpha = 0,34$ ; group c,  $\alpha = 0,49$ ; group d,  $\alpha = 0,76$ .

- **Flexural buckling**

The slenderness parameter  $\lambda$  is calculated as:

$$\lambda = (A f_y / N_{cr})^{0,5}$$

$N_{cr}$  is the critical load considering flexural buckling around the relevant axis.

$$N_{cry} = E I_y (\pi / L_{cry})^2; N_{crz} = E I_z (\pi / L_{crz})^2$$

$L_{cr}$  is the buckling length.

- **Torsional buckling and flexural-torsional buckling**

Torsional and flexural-torsional buckling is calculated according to EN 1993-1-1 6.3.1.4.

The slenderness parameter  $\lambda_T$  is calculated as:

$$\lambda_T = (A f_y / N_{cr})^{0.5}$$

where  $N_{cr} = N_{cr,TF}$  and  $N_{cr} < N_{cr,T}$

$N_{cr,TF}$  is the elastic torsional-flexural buckling force,

$N_{cr,T}$  is the elastic torsional buckling force,

The critical load with regard to torsional buckling is calculated as:

$$N_{cr,T} = 1 / i_p^2 (G I_T + E I_w (\pi / L_{cr})^2)$$

$G$  is the shear modulus,

$i_p$  is the polar radius of gyration which in this case is  $i_p = ((I_y + I_z) / A)^{0.5}$

$L_{cr}$  is the relevant buckling length,

$N_{cr,TF}$  is the critical load considering flexural-torsional buckling and is the lowest root to the third grade equation:

$$(N_{cry} - N_{cr,TF}) (N_{crz} - N_{cr,TF}) (N_{cr,T} - N_{cr,TF}) - (N_{cry} - N_{cr,TF}) N_{cr,TF}^2 e_z^2 / i_p^2 - (N_{crz} - N_{cr,TF}) N_{cr,TF}^2 e_y^2 / i_p^2 = 0$$

$N_{cry}$  is the critical load with regard to flexural buckling around the **y**-axis as described above,

$N_{crz}$  is the critical load with regard to flexural buckling around the **z**-axis as described above,

$N_{cr,T}$  is the critical load with regard to torsional buckling as described above,

$e_y$  is the distance between the centre of gravity and the shear centre in the **y**-direction,

$e_z$  is the distance between the centre of gravity and the shear centre in the **z**-direction,

The polar radius of gyration is  $i_p = ((I_y + I_z) / A + e_y^2 + e_z^2)^{0.5}$

### 2.3.4.3 Bending moment capacity

The capacity is calculated according to EN 1993-1-1 6.2.5 and 6.3.2.4.

The capacity is calculated as:

- **Section class 1 and 2**

$$M_{c,Rd} = W_{pl} f_y / \gamma_{M0}$$

$$M_{b,Rd} = k_{fl} \chi W_{pl} f_y / \gamma_{M1} \text{ (capacity with regard to lateral-torsional buckling)}$$

where:  $W_{pl}$  is plastic section modulus,

$f_y$  is design strength,

$\gamma_{M0}$ ,  $\gamma_{M1}$  is partial factors,

$k_{fl}$  modification factor accounting for the conservatism of the equivalent compression flange method,

$\chi$  is reduction factor of the equivalent compression flange.

- **Lateral-torsional buckling**

Lateral torsional buckling is calculated with the simplified assessment method according to EN 1993-1-1 6.3.2.4, flexural buckling of the compressed flange.

The reduction factor  $\chi$  is calculated as shown above for flexural buckling of the compressed flange.

- **Section class 3**

$$M_{c,Rd} = W_{el} f_y / \gamma_{M0}$$

$$M_{b,Rd} = k_{fl} \chi W_{el} f_y / \gamma_{M1}$$

$W_{el}$  elastic section modulus.

### 2.3.4.4 Shear capacity

Calculated according EN 1993-1-1 6.2.6, EN 1993-1-5 5.1-5.3.

The capacity is calculated as:

$$V_{pl,Rd} = A_v f_y / 3^{0.5} / \gamma_{M0}$$

## Shear area

- **Solid sections**

$A_v =$  cross sectional area

- **Rolled I and H sections, load parallel to web**

$$A_v = A - 2 b t_f + (t_w + 2r) t_f \geq \eta h_w t_w$$

- **Rolled channel sections, load parallel to web**

$$A_v = A - 2 b t_f + (t_w + r) t_f$$

- **Rolled T- section, load parallel to web**

$$A_v = 0,9 (A - b t_f)$$

- **Welded I, H and box sections, load parallel to web**

$$A_v = \eta \Sigma (h_w t_w)$$

- **Welded I, H, channel and box sections, load parallel to flanges**

$$A_v = A \Sigma (h_w t_w)$$

- **Rolled rectangular hollow sections of uniform thickness:**

load parallel to depth  $A_v = A h / (b + h)$

load parallel to width  $A_v = A b / (b + h)$

- **Circular hollow sections and tubes of uniform thickness**

$$A_v = 2 A / \pi$$

$\eta$  is taken as 1,0.

In cases not included above the elastic capacity is calculated as:

$$\tau_{Ed} / (f_y / (3^{0,5} \gamma_{M0})) \leq 1,0$$

## Web buckling

Calculated according to EN 1993-1-5 5.2

Web buckling is considered if:

$$h_w / t_w > 72 \varepsilon / \eta$$

$$\varepsilon = (235 / f_y)^{0.5}$$

$$\eta = 1,2 \text{ for steel grades up to S460 then } \eta = 1,0$$

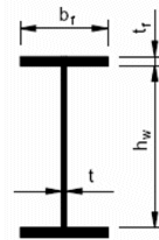

The capacity is calculated as:

$$V_{b,Rd} = V_{bw,Rd} + V_{bf,Rd} \leq \eta f_{yw} h_w t_w / (3^{0.5} \gamma_{M1})$$

Contribution from web:

$$V_{bw,Rd} = \chi_w f_{yw} h_w t_w / (3^{0.5} \gamma_{M1})$$

The shear buckling factor  $\chi_w$  is calculated as:

	Rigid end post	Non-rigid end post
$\bar{\lambda}_w < 0,83 / \eta$	$\eta$	$\eta$
$0,83 / \eta \leq \bar{\lambda}_w < 1,08$	$0,83 / \bar{\lambda}_w$	$0,83 / \bar{\lambda}_w$
$\bar{\lambda}_w \geq 1,08$	$1,37 / (0,7 + \bar{\lambda}_w)$	$0,83 / \bar{\lambda}_w$

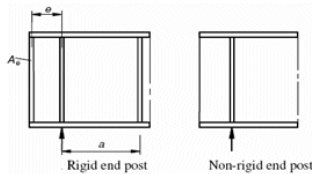

The program will understand that the member has a non-rigid end post if no stiffeners are defined and as a rigid end post if a stiffener is defined at the very end of the member. For slender webs the capacity can be increased by defining additional stiffeners as shown below.

No transverse stiffeners defined:

$$\text{Slenderness parameter } \lambda_w = h_w / (86,4 t_w \varepsilon)$$

else:

$$\text{Slenderness parameter } \lambda_w = h_w / (37,4 t_w \varepsilon \kappa_t^{0.5})$$



$$\kappa_{\tau} = 5,34 + 4,0 (h_w/a)^2; a/h_w \geq 1$$

$$\kappa_{\tau} = 4,0 + 5,34 (h_w/a)^2; a/h_w < 1$$

**a** = largest distance between transverse stiffeners in the member.

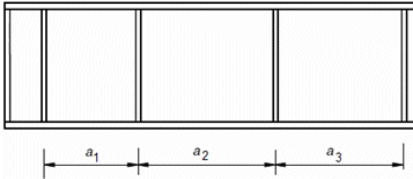

$$a = \max(a_1, a_2, a_3 \dots)$$

### Contribution from flange

When the flange resistance is not completely utilized in resisting the bending moment ( $M_{Ed} < M_{f,Rd}$ ) the contribution from the flanges are calculated as:

$$V_{bf,Rd} = b_f t_f f_{yf} / (c \gamma_{M1}) (1 - (M_{Ed} / M_{f,Rd})^2)$$

$$b_f \leq 15 \varepsilon t_f$$

### 2.3.4.5 Shear and Torsion

The capacity is calculated according to EN 1993-1-1 6.2.7.

The capacity is calculated as:

- **I, H-sections or channel sections**

$$V_{pl,T,Rd} = [(1 - \tau_{T,Ed} / (1,25 (f_y / 3^{0,5}) / \gamma_{M0})] V_{pl,Rd}$$

where:  $V_{pl,Rd}$  is the shear capacity as above.

- **Hollow sections**

$$V_{pl,T,Rd} = [(1 - \tau_{T,Ed} / ((f_y / 3^{0,5}) / \gamma_{M0})] V_{pl,Rd}$$

### 2.3.4.6 Warping torsion (Vlasov torsion)

Warping torsion is not considered in the present version.

## 2.4 Timber Design

### 2.4.1 General

The following design considers EC5 (standard) and the National Annex (NA) for Denmark, Finland, Hungary, Norway and Sweden.

With the timber module arbitrary structures in space can be designed with regard to a 1<sup>th</sup> order or a 2<sup>nd</sup> order analysis.

In the **Code Check** all checks prescribed in the codes depending on acting section forces displayed.

### 2.4.2 Global analysis

#### 2.4.2.1 General

The design can be performed using either:

- 1<sup>th</sup> order analysis, using the initial geometry of the structure or,
- 2<sup>nd</sup> order analysis, taking into account the influence of the deformation of the structure.

#### 2.4.2.2 Structural stability

The calculations with regard to instability will be performed in different ways depending on the type of analysis.

##### 2.4.2.2.1 1<sup>th</sup> order theory

For a 1<sup>th</sup> order design the following apply:

Both the flexural and lateral torsional buckling are calculated depending on the slenderness with respect to reduction factors specified in the appropriate code. The reduced slenderness for flexural buckling may be computed as:

$$\lambda = [A F' / N_{cr}]^{1/2}$$

The critical normal force for flexural buckling  $N_{cr}$  will in this case be calculated using appropriate buckling lengths defined by the user in both directions for all members.

The reduced slenderness for lateral torsional buckling may be computed as:

$$\lambda_{LT} = [W f_y / M_{cr}]^{1/2}$$

The critical moment  $M_{cr}$  will be calculated according to support conditions and load levels defined by the user for all members.

### **Imperfections**

Initial bow imperfections may be neglected as these effects are included in the formulas for buckling resistance of the members.

For sway mode structures initial sway imperfections has to be considered. This could be done by changing the geometry before calculation or by defining systems of equivalent horizontal forces as described below.

#### **2.4.2.2.2 2<sup>nd</sup> order theory**

A 2<sup>nd</sup> order calculation produces the critical normal force  $N_{cr}$  for flexural buckling and a corresponding stability check is not required. The critical moment  $M_{cr}$  are not calculated since a basic finite element only contains the second order effects of the axial force. The effect of the lateral torsional buckling will then have to be calculated as for 1th order above.

### **Imperfections**

For all structures initial deformations should be considered. See EN 1995-1-1 5.4.4.

As the flexural buckling design is based on the 2<sup>nd</sup> order effects of the bending moments it is vital that there is a moment distribution in all members. By considering initial deformations this is ensured also for hinged members without lateral load.

**Note!** It is up to the user to ensure that all members have a 1<sup>th</sup> order moment distribution so the 2<sup>nd</sup> order effect and thereby also the buckling effect is considered.

For sway mode structures also initial sway imperfections has to be considered. This could be done in the conventional way by changing the geometry before calculation or by defining systems of equivalent horizontal forces as described in 2.4.2.3.1 below.

**Note!** When performing a 2<sup>nd</sup> order calculation a division of the members in more than one finite element could strongly influence the result. It is recommended to divide members in compression into an even member of elements e.g. four.

### 2.4.2.3 Imperfections for global analysis of frames

The following imperfections should be taken into account:

1. Global imperfections for the structure as a whole.
2. Local imperfections for individual members.

#### 2.4.2.3.1 Conventional method

- **Global initial sway imperfections**

This effect could be considered in two ways.

1. By changing the frame geometry before analysis with the slope  $\varphi$  as shown below.

The slope  $\varphi$  will be calculated according to the relevant code.

2. By defining a system of equivalent horizontal forces as shown below:

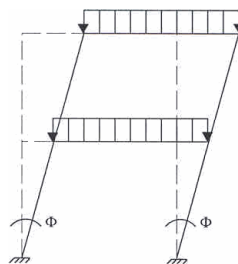

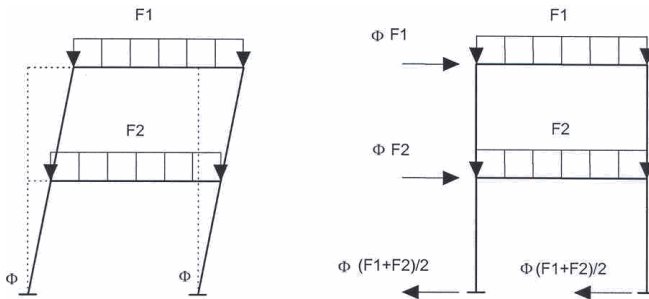

Where, in multi-storey beam and column building frames, equivalent forces are used they should be applied at each floor and roof level.

These initial sway imperfections should apply in all relevant horizontal directions, but need only be considered in one direction at a time.

The possible torsional effects on a structure caused by anti-symmetric sways at the two opposite faces, should also be considered.

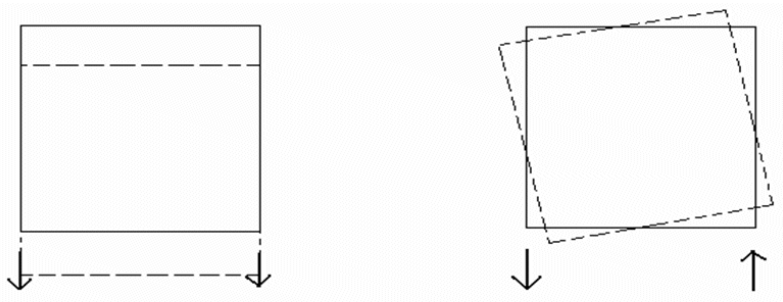

*Translational sway*

*Rotational sway*

- **Relative initial local bow imperfections of members for flexural buckling**

Equivalent horizontal forces introduced for each member as shown below could consider this effect.

The value  $e_0$  considering initial bow deformation is calculated according to EN 1995-1-1 5.4.4.

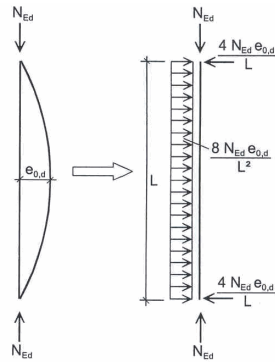

### 2.4.3 Ultimate limit state

For a second order linear elastic analysis of a structure, design values, not adjusted for duration of load, shall be used.

### 2.4.4 Load duration classes

Actions shall be assigned to one of the load-duration classes given in EN 1995-1-1 table 2.1.

Examples of load-duration assignment are given in EN 1995-1-1 table 2.2.

### 2.4.5 Service classes

Structures shall be assigned to one of three service classes according to EN 1995-1-1 2.3.1.3.

### 2.4.6 Materials and product properties

#### 2.4.6.1 Load-duration and moisture influences on strength

The influence of load-duration and moisture content on strength is considered by the modification factor  $k_{mod}$ , see EN 1995-1-1 table 3.1.

## 2.4.6.2 Load-duration and moisture influences on deformations

### Serviceability Limit State

If the structure consists of members having different time-dependent properties, the final mean values of modulus of elasticity, shear modulus and slip modulus are calculated with the following expressions:

$$E_{\text{mean,fin}} = E_{\text{mean}} / (1 + k_{\text{def}})$$

$$G_{\text{mean,fin}} = G_{\text{mean}} / (1 + k_{\text{def}})$$

$$K_{\text{ser,fin}} = K_{\text{ser}} / (1 + k_{\text{def}})$$

### Ultimate Limit State

The final mean value of modulus of elasticity, shear modulus and slip modulus are calculated with the following expressions:

$$E_{\text{mean,fin}} = E_{\text{mean}} / (1 + \Psi_2 k_{\text{def}})$$

$$G_{\text{mean,fin}} = G_{\text{mean}} / (1 + \Psi_2 k_{\text{def}})$$

$$K_{\text{ser,fin}} = K_{\text{ser}} / (1 + \Psi_2 k_{\text{def}})$$

where:  $k_{\text{def}}$  is a factor for the evaluation of creep deformation given in EN 1995-1-1 table 3.2.

$\Psi_2$  is the factor for the quasi-permanent value of the action according to EN 1990 table A1.1. For permanent actions  $\Psi_2 = 1,0$ .

## 2.4.7 Verification by the partial factor method

### 2.4.7.1 Design value of material property

The design value of  $X_d$  of a strength property shall be calculated as:

$$X_d = k_{\text{mod}} X_k / \gamma_M$$

where:  $X_d$  is the characteristic value of a strength property,

$k_{mod}$  is a modification factor taking into account the effect of the duration of load and moisture content according to EN 1995-1-1 table 3.1,

$\gamma_M$  is the partial factor for a material property according to table 2.3 below.

Table 2.3 - Recommended partial factors  $\gamma_M$  for material properties and resistances:

Fundamental combinations:	
Solid timber	1,3
Glued laminated timber	1,25
LVL, plywood, OSB,	1,2
Particleboards	1,3
Fibreboards, hard	1,3
Fibreboards, medium	1,3
Fibreboards, MDF	1,3
Fibreboards, soft	1,3
Connections	1,3
Punched metal plate fasteners	1,25
Accidental combinations	1,0

### NA Norway

LVL, plywood, OSB  $\gamma_M = 1,3$

### NA Finland

Solid timber < C35  $\gamma_M = 1,4$

Solid timber  $\geq$  C35  $\gamma_M = 1,25$

Glued laminated timber  $\gamma_M = 1,2$

Plywood, OSB, Particleboards, Fibreboards  $\gamma_M = 1,25$

### NA Denmark

Solid timber  $\gamma_M = 1,35 \gamma_3$

Glued laminated timber  $\gamma_M = 1,3 \gamma_3$

LVL, Plywood, OSB, Particleboards, Fibreboards  $\gamma_M = 1,3 \gamma_3$



The factor  $\gamma_3$  is chosen according to the following:

Inspection level	Tightened	Normal	Relaxed
$\gamma_3$	0,95	1,0	1,10

The design member stiffness properties shall be calculated as:

$$E_d = E_{\text{mean}} / \gamma_M$$

$$G_d = G_{\text{mean}} / \gamma_M$$

where:  $E_{\text{mean}}$  is the mean value of modulus of elasticity,

$G_{\text{mean}}$  is the mean value of shear modulus

## 2.4.8 Material properties

EN 1995-1-1 ch. 3

### 2.4.8.1 Solid Timber

#### 2.4.8.1.1 Strength classes

EN 1995-1-1 3.2, EN 338 5

Table 1 -- Strength classes - Characteristic values:

		Poplar and softwood species												
		C14	C16	C18	C20	C22	C24	C27	C30	C35	C40	C45	C50	
Strength properties (in N/mm <sup>2</sup> )														
Bending	$f_{m,k}$	14	16	18	20	22	24	27	30	35	40	45	50	
Tension parallel	$f_{t,0,k}$	8	10	11	12	13	14	16	18	21	24	27	30	
Tension perpendicular	$f_{t,90,k}$	0,4	0,5	0,5	0,5	0,5	0,5	0,6	0,6	0,6	0,6	0,6	0,6	
Compression parallel	$f_{c,0,k}$	16	17	18	19	20	21	22	23	25	26	27	29	
Compression perpendicular	$f_{c,90,k}$	2,0	2,2	2,2	2,3	2,4	2,5	2,6	2,7	2,8	2,9	3,1	3,2	
Shear	$f_{v,k}$	1,7	1,8	2,0	2,2	2,4	2,5	2,8	3,0	3,4	3,8	3,8	3,8	
Stiffness properties (in kN/mm <sup>2</sup> )														
Mean modulus of elasticity parallel	$E_{0,mean}$	7	8	9	9,5	10	11	11,5	12	13	14	15	16	
5% modulus of elasticity parallel	$E_{0,05}$	4,7	5,4	6,0	6,4	6,7	7,4	7,7	8,0	8,7	9,4	10,0	10,7	
Mean modulus of elasticity perpendicular	$E_{90,mean}$	0,23	0,27	0,30	0,32	0,33	0,37	0,38	0,40	0,43	0,47	0,50	0,53	
Mean shear modulus	$G_{mean}$	0,44	0,5	0,56	0,59	0,63	0,69	0,72	0,75	0,81	0,88	0,94	1,00	
Density (in kg/m <sup>3</sup> )														
Density	$\rho_k$	290	310	320	330	340	350	370	380	400	420	440	460	
Mean density	$\rho_{mean}$	350	370	380	390	410	420	450	460	480	500	520	550	

Table 1 -- Strength classes - Characteristic values:

		Hardwood species					
		D30	D35	D40	D50	D60	D70
Strength properties (in N/mm <sup>2</sup> )							
Bending	$f_{m,k}$	30	35	40	50	60	70
Tension parallel	$f_{t,0,k}$	18	21	24	30	36	42
Tension perpendicular	$f_{t,90,k}$	0,6	0,6	0,6	0,6	0,6	0,6
Compression parallel	$f_{c,0,k}$	23	25	26	29	32	34
Compression perpendicular	$f_{c,90,k}$	8,0	8,4	8,8	9,7	10,5	13,5
Shear	$f_{v,k}$	3,0	3,4	3,8	4,6	5,3	6,0
Stiffness properties (in kN/mm <sup>2</sup> )							
Mean modulus of elasticity parallel	$E_{0,mean}$	10	10	11	14	17	20
5% modulus of elasticity parallel	$E_{0,05}$	8,0	8,7	9,4	11,8	14,3	16,8
Mean modulus of elasticity perpendicular	$E_{90,mean}$	0,64	0,69	0,75	0,93	1,13	1,33
Mean shear modulus	$G_{mean}$	0,60	0,65	0,70	0,88	1,06	1,25
Density (in kg/m <sup>3</sup> )							
Density	$\rho_k$	530	560	590	650	700	900
Mean density	$\rho_{mean}$	640	670	700	780	840	1080

For rectangular solid timber with a characteristic density  $\rho_k \leq 700 \text{ kg/m}^3$  and depths in bending or widths in tension less than 150 mm the characteristic values for  $f_{m,k}$  and  $f_{t,0,k}$  may be increased by the factor  $k_h$  given by:

$$k_h = \min [ (150 / h)^{0.2}, 1,3 ]$$

where: **h** is the depth for bending members or width for tension members, in mm.

## 2.4.8.2 Glued laminated timber

### 2.4.8.2.1 Strength classes

EN 1995-1-1 3.3, EN 1194 5

Table 2 -- Strength classes - Characteristic values:

Glulam		GL 24c	GL 28c	GL 32c	GL 36c
Bending	$f_{m,glk}$	24	28	32	36
Tension	$f_{t,0,glk}$	14	16,5	19,5	22,5
	$f_{t,0,glk}$	0,35	0,4	0,45	0,5
Compression	$f_{c,0,glk}$	21	24	26,5	29
	$f_{c,0,glk}$	2,4	2,7	3,0	3,3
Shear	$f_{v,glk}$	2,2	2,7	3,2	3,8
Mean modulus of elasticity	$E_{0,gl,mean}$	11 600	12 600	13 700	14 700
	$E_{0,gl,0c}$	9 400	10 200	11 100	11 900
	$E_{90,gl,mean}$	320	390	420	460
Mean shear modulus	$G_{gl,mean}$	590	720	780	850
Density	$\rho_{glk}$	350	380	410	430

From these tables the following standard classes must be available:

Solid timber: C14, C16, C18, C20, C22, C24, C27, C30, C35, C40, C45, C50, D30, D35, D40, D50, D60, D70.

Glued laminated timber: GL 24, GL 28, GL 32, GL 36.

Any user defined material will also be possible to define.

As the modulus of elasticity and shear modulus are dependent of each other either one or the other could be defined by the user for user defied materials.

For rectangular glued laminated timber with depths in bending or widths in tension less than 600 mm the characteristic values for  $f_{m,k}$  and  $f_{t,0,k}$  may be increased by the factor  $k_h$  given by:

$$k_h = \min [ (600 / h )^{0.1} , 1,1 ]$$

where: **h** is the depth for bending members or width for tension members, in mm.



# 3 Section Editor

## 3.1 Basics

The section editor program is an independent but well-connected part of the **FEM-Design** package. This part is for creating, calculating and organizing cross-sections for the **FEM-Design**.

The section database can be reached and used from the other parts of the **FEM-Design** package (**Plate**, **3D Frame** and **3D Structure** modules).

In the section database of the **FEM-Design** the shape of the sections are defined by so called regions. A region is a contour formed by lines and arcs and might have holes in it formed also from arcs and lines. A cross-section could be defined by more than one region.

The sections in the section database are material independent, however on creation some material like parameters can be defined and the sections are divided into groups by the possible usage of the section. For example a solid rectangle section usually is not a steel section but can be concrete or wooden. An IPE 100 on the right usage is a steel cross-section but nothing in the **FEM-Design** restrains you from using the shape with other materials too. The material-like parameters are for example rolled steel; cold worked steel; generic section; and other similar information (refer to the **User's Guide** of the **FEM-Design**). This information is for future use currently but please define correctly at every cross-section.

Not just the shape of the cross-section is stored in the section database of the **FEM-Design**, but the geometrical parameters too, like area, inertia, section modulus and so on. The section parameter calculation engine in the section editor calculates these values.

The calculation of the geometric parameters is a finite element calculation. In the background of the calculation of the geometrical parameters a suitable finite element mesh is generated on the same basics that are described in the section 1.1.10.

The next chapter gives information about the theory of the geometric parameters calculation.

### 3.2 Calculation of the geometrical properties

Beam finite elements of arbitrary cross sections are important members of finite element models for a variety of practical applications. In the effective use of such elements, at the modelling stage, the user is faced with the time consuming problem of accurate determination of beam cross sectional properties.

In the analysis of beams, the following local coordinate systems and notations are used (see Fig. 1):

- **N** node of finite element mesh,
- **G** centroid,
- **S** shear centre,
- **x, y, z** local coordinates, where **x** is passing through element nodes,
- **x', y', z'** central axes, parallel to **x, y, z** (i.e. **x'** is the beam axis),
- **y<sub>G</sub>, z<sub>G</sub>** coordinates of **G** centroid, relative to **N** node,
- **y<sub>S</sub>, z<sub>S</sub>** coordinates of **S** shear (torsion) centre, relative to **G** centroid,
- **e<sub>xmax</sub>, e<sub>xmin</sub>, e<sub>ymax</sub>, e<sub>ymin</sub>, e<sub>1max</sub>, e<sub>1min</sub>, e<sub>2max</sub>, e<sub>2min</sub>** distances of extreme fibres.

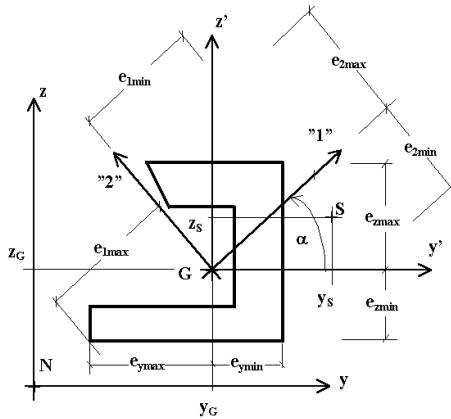

Fig. 1

The cross sectional properties are related to internal forces, namely tension, bending, torsion (free or constrained) and shear. The general solution of elastic beam problems can be found in many textbooks, for example in references [3] and [4], only the definitions and final results will be presented.

### 3.2.1 Tension, bending

The well known formula calculating the normal stress distribution due to tension and bending:

$$\sigma_x = \frac{N}{A} + M_y \frac{I_z z - I_{yz} y}{D} - M_z \frac{I_y y - I_{yz} z}{D}$$

The cross sectional properties appearing here are:

area:

$$A = \int_A dA \quad (1)$$

co-ordinates of centroid:

$$y_G = \frac{1}{A} \int_A y dA, \quad z_G = \frac{1}{A} \int_A z dA \quad (2)$$

moment of inertia with respect to centroidal

$$\text{axes: } I_y = \int_A z^2 dA, \quad I_z = \int_A y^2 dA, \quad I_{yz} = \int_A zy dA, \quad D = I_y - I_z - I_{yz}^2 \quad (3)$$

The principal moments of inertia and the angle  $\alpha$  of the **1** principal axis are:

$$\alpha = \text{atan} \left( 2 \frac{I_{yz}}{I_z - I_y} \right) \quad (4)$$

$$I_1 = I_y \cos^2 \alpha + I_z \sin^2 \alpha - I_{yz} \sin 2\alpha, \quad I_2 = I_y \sin^2 \alpha + I_z \cos^2 \alpha - I_{yz} \sin 2\alpha$$

Using the principal axes as local coordinate directions, the maximums of bending stress components are:

$$\sigma_{x,1\max} = \frac{|M_1|}{W_1}, \quad \sigma_{x,2\max} = \frac{|M_2|}{W_2}$$

where the sectional properties are the principal section moduli:

$$W_1 = \frac{I_1}{e_{2\max}}, \quad W_2 = \frac{I_2}{e_{1\max}} \quad (5)$$

In many tension/compression and bending related problems (eq. eccentric compression, the slenderness calculation) the radius of inertia is used. The definitions of radius of principal inertia are:

$$i_1 = \sqrt{\frac{I_1}{A}}, \quad i_2 = \sqrt{\frac{I_2}{A}} \quad (6)$$

### 3.2.2 Elastic-plastic bending

The normal stress distribution due to simple bending of section, supposing the material is perfectly elastic-plastic (no strain hardening) is shown in Fig. 2. The axis  $\xi$  is passing through the **G** centroid, while the line  $\eta$  divides the area into halves. The  $\xi$  axis of bending is either one of principal axes or parallel to one of the symmetry lines.

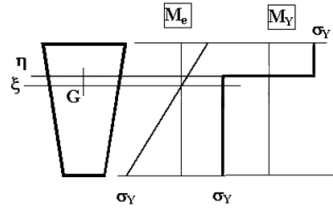

Fig. 2

There are two specific moments,  $\mathbf{M}_e$  elastic limit moment when the maximum stress equals to the  $\sigma_Y$  yield stress,

$$\sigma_{x\max} = \sigma_y = \frac{M_e}{W_\xi}, \quad M_e = \sigma_y W_\xi$$

and the  $\mathbf{M}_Y$  plastic limit (ultimate) moment:

$$M_y = 2\sigma_y S_{0\xi} \quad (7)$$

where:  $S_{0\xi}$  is the static (linear) moment of half area with respect to the axis  $\xi$ . The elastic-plastic moment capacity is defined as:

$$e_\xi = \frac{M_y}{M_e} = \frac{2S_{0\xi}}{W_\xi} \geq 1.0 \quad (8)$$

### 3.2.3 Free torsion

Due to a torque  $\mathbf{M}_x$  each section of a straight beam undergoes a rotation about the point **S**, here called of torsion centre. In case of free torsion-when the torsional warping of the cross section is not constrained-the rate of twist is constant. Assuming homogeneous, elastic material, the shear stress distributions are given as:

$$\tau_{xy} = \frac{M_x}{I_t} \left( \frac{\partial \varphi}{\partial y} - z \right), \quad \tau_{xz} = \frac{M_x}{I_t} \left( \frac{\partial \varphi}{\partial z} + y \right)$$

The cross sectional property is the torsion moment of inertia:

$$I_t = I_y + I_z - \int_A \left( z \frac{\partial \varphi}{\partial z} - y \frac{\partial \varphi}{\partial y} \right) dA \quad (9)$$

and the co-ordinates of **S** torsion centre:

$$y_s = - \left( I_z \int_A z \varphi dA - I_{yz} \int_A y \varphi dA \right) / D, \quad z_s = - \left( I_y \int_A y \varphi dA - I_{yz} \int_A z \varphi dA \right) / D \quad (10)$$

The maximum of torsion stresses can be calculated with the  $\mathbf{W}_t$  torsion section modulus as:



$$\tau_{\max} = \left( \sqrt{\tau_{xy}^2 + \tau_{xz}^2} \right)_{\max} = \frac{M_x}{W_t} \quad (11)$$

It follows from the internal equilibrium of linear elasticity and the boundary conditions that the  $\phi(\mathbf{y}, \mathbf{z})$  warping function is the solution of the following differential equation:

$$\frac{\partial^2 \phi}{\partial y^2} + \frac{\partial^2 \phi}{\partial z^2} = 0, \quad \left( \frac{\partial \phi}{\partial y} - z \right) \mathbf{m} + \left( \frac{\partial \phi}{\partial z} - y \right) \mathbf{n} = 0 \quad (I.)$$

where:  $\mathbf{m}$  and  $\mathbf{n}$  are the components of outward unit normal vector of section contour.

### 3.2.4 Constrained torsion

If the torsional warping of the cross section of the straight beam is constrained, in addition to the shear stresses a secondary normal stress distribution appears:

$$\sigma_x = \frac{B}{I_\Gamma} (\phi - yz_s + zy_s)$$

In this equation  $B(\mathbf{x})$  is the bimoment and the cross sectional property is the warping parameter defined as:

$$I_\Gamma = \int_A (\phi - yz_s + zy_s)^2 dA \quad (12)$$

For thin walled sections the warping function or the sector area function with pole  $S$  is:

$$\omega \approx (\phi - yz_s + zy_s)$$

### 3.2.5 Shear

The beam is free of torsion if the  $\mathbf{V}_y$  and  $\mathbf{V}_z$  shear forces are passing through the  $S$  point. It follows from the Betti's theorem, that the centre point of torsional rotation of the section and the shear centre are identical. The shear stress distributions from the  $\psi_1(\mathbf{y}, \mathbf{z})$  and  $\psi_2(\mathbf{y}, \mathbf{z})$  shear stress functions can be calculated as:

$$\tau_{xy} = \frac{V_y}{A} \frac{\partial \psi_1}{\partial y} + \frac{V_z}{A} \frac{\partial \psi_2}{\partial y}, \quad \tau_{xz} = \frac{V_y}{A} \frac{\partial \psi_1}{\partial z} + \frac{V_z}{A} \frac{\partial \psi_2}{\partial z}$$

In using the finite element method for elastic structures, the stiffness matrix is derived from the  $U$  internal energy. The  $U_s$  shear contribution of the beam internal energy per unit length, with shear modulus  $G$ , is:

$$U_s = \frac{1}{2G} \int_A (\tau_{xy}^2 + \tau_{xz}^2) dA = \frac{1}{2GA} \left( \frac{V_y^2}{\rho_y} + \frac{V_z^2}{\rho_z} + \frac{V_y V_z}{\rho_{yz}} \right)$$

The cross sectional properties are the shear factors:

$$\rho_y^{-1} = \int_A \frac{\psi_1(I_{yy} - I_{yz}z)}{D} dA, \quad \rho_z^{-1} = \int_A \frac{\psi_2(I_{zz} - I_{yz}y)}{D} dA,$$

$$\rho_{yz}^{-1} = \int_A \frac{\psi_1(I_{zz} - I_{yz}y) + \psi_2(I_{yy} - I_{yz}z)}{D} dA \quad (13)$$

Transforming the  $y, z$  coordinates into the **1** and **2** principal directions, the shear factors are the principal shear factors:

$$\rho_1 = \rho_y, \quad \rho_2 = \rho_z, \quad \text{and} \quad \rho_{12} = \rho_{yz} = 0$$

The quantities  $A_1 = (A \rho_1)$  and  $A_2 = (A \rho_2)$  are called by shear areas.

From the condition of internal equilibrium two boundary value problems can be derived:

if  $V_y = 1$  and  $V_z = 0$ ,

$$\frac{\partial^2 \psi_1}{\partial y^2} + \frac{\partial^2 \psi_1}{\partial z^2} = -\frac{A}{D} (I_{yy} - I_{yz}z), \quad \frac{\partial \psi_1}{\partial y} \mathbf{m} + \frac{\partial \psi_1}{\partial z} \mathbf{n} = 0 \quad (13)$$

if  $V_y = 0$  and  $V_z = 1$ ,

$$\frac{\partial^2 \psi_2}{\partial y^2} + \frac{\partial^2 \psi_2}{\partial z^2} = -\frac{A}{D} (I_{zz} - I_{yz}y), \quad \frac{\partial \psi_2}{\partial y} \mathbf{m} + \frac{\partial \psi_2}{\partial z} \mathbf{n} = 0 \quad (14)$$

where:  $\mathbf{m}$  and  $\mathbf{n}$  are the components of outward unit normal vector of section contour.

The approximate distribution of shear stress in a thin walled section takes the form:

$$\tau_{sx}(s) = -\frac{V_y}{t(s)D} [I_y S_y(s) - I_{yz} S_y(s)] - \frac{V_z}{t(s)D} [I_z S_z(s) - I_{yz} S_z(s)]$$

where:  $S_y$  and  $S_z$  are the static (linear) moment functions:

$$S_y(s) = \int_A^{P(s)} z t ds, \quad S_z(s) = \int_A^{P(s)} y t ds \quad (15)$$

Using the principal axes as local coordinate directions the shear stress distribution is:

$$\tau_{sx}(s) = \frac{V_1 S_2(s)}{t(s) I_2} - \frac{V_2 S_1(s)}{t(s) I_1}$$

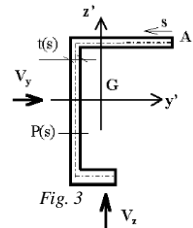

### 3.2.6 Lateral buckling

In the lateral-torsion buckling analysis of non symmetric section columns the so-called Wagner's coefficients are used. They are defined as follows:

$$\beta_y = \frac{1}{I_y} \int_A z(y^2 + z^2) dA - 2z_s, \quad \beta_z = \frac{1}{I_z} \int_A y(y^2 + z^2) dA - 2y_s$$

$$\beta_\omega = \frac{1}{I_\omega} \int_A \omega(y^2 + z^2) dA \quad (16)$$

In the local system of "1" and "2" principal axes (see Fig.1):

$$z_1 = \beta_y, \quad z_2 = \beta_z, \quad z_\omega = \beta_\omega \quad (17)$$

These properties for a double symmetric section are zeros, so they can be termed as asymmetry properties. If the principal axis "1" is a symmetry line of the section than  $z_1$  equals to zero and same holds for  $z_2$ .

### 3.2.7 Finite element method for sections

The (I.), (II.) and (III.) elliptic boundary value problems can be transformed into the following energy principles or weak forms:

$$\Pi_0 = \int_A \left\{ \frac{1}{2} \left[ \left( \frac{\partial \varphi}{\partial y} \right)^2 + \left( \frac{\partial \varphi}{\partial z} \right)^2 \right] - \left( \frac{\partial \varphi}{\partial y} z + \frac{\partial \varphi}{\partial z} y \right) \right\} dA = \text{extr} \quad (\text{Ia.})$$

$$\Pi_1 = \int_A \left\{ \frac{1}{2} \left[ \left( \frac{\partial \psi_1}{\partial y} \right)^2 + \left( \frac{\partial \psi_1}{\partial z} \right)^2 \right] - \psi_1 (I_{yz} - I_{zz}) \frac{A}{D} \right\} dA = \text{extr} \quad (\text{IIa.})$$

$$\Pi_2 = \int_A \left\{ \frac{1}{2} \left[ \left( \frac{\partial \psi_2}{\partial y} \right)^2 + \left( \frac{\partial \psi_2}{\partial z} \right)^2 \right] - \psi_2 (I_{zz} - I_{yyz}) \frac{A}{D} \right\} dA = \text{extr} \quad (\text{IIIa.})$$

These problems can be solved by a 2D finite element method, where the stiffness matrix, derived from the quadratic part of principles, are the same. The only differences are in the linear parts, which are leading to three different right hand sides. Using a quadratic (8 or 6 node) isoparametric finite element formulation with one degree of freedom per node, the cross sectional properties can be calculated. The average element size is calculated automatically and the mesh is generated automatically too using this average element size. All integrals are calculated by Gauss quadratures.

<b>Property</b>		<b>Equation</b>
A	area	(1)
$y_G, z_G$	coordinates of centroid	(2)
$y_s, z_s$	coordinates of shear (torsion) centre	(I.), (10)
$I_y, I_z, I_{yz}$	second moment of inertia	(3)
$I_1, I_2$	principal moments of inertia	(4)
$\alpha$	angle of local <b>x</b> and "1" principal direction	(4)
$W_1, W_2$	principal section modulus	(5)
$W_y, W_z$	section modulus	$W_y = I_y / e_{zmax}$ $W_z = I_z / e_{ymax}$
$i_1, i_2$	radius of principal inertia	(6)
$i_y, i_z$	radius of inertia	$i_y = \sqrt{\frac{I_y}{A}}$ . $i_z = \sqrt{\frac{I_z}{A}}$ .
$\rho_1, \rho_2$	principal shear factors	(II.), (III.), (14)
$\rho_y, \rho_z, \rho_{yz}$	shear factors	(II.), (III.), (13)
$I_t$	torsion moment of inertia	(9)
$W_t$	torsion section modulus	(11)
$I_\Gamma$	warping parameter	(12)
$S_{ymax}, S_{zmax}$	maximum of static moments	(15)
$S_{1max}, S_{2max}$	maximum of principal static moments	(15)
$S_{01}, S_{02}$	principal static moment of half section	(7)
$c_1, c_2$	plastic/elastic moment capacity	(8)
$z_1, z_2, z_0$	Wagner's parameters	(16), (17)

## 4 Geotechnical module

More detailed information will be available in the near future.

## 5 References

1. *FEM-Design User's Guide*, manual Structural Design Software, 2010.
2. *Ferde vasalású vasbeton lemez számítási algoritmus*, Dr. Németh Ferenc.
3. *Mechanics of Elastic Structures*, Oden, J.T, MacGraw Hill, 1967.
4. *Mechanics of Solids with Application to thin Bodies*, Wempner G, Sijthoff Noordhoff, 1981.
5. *Isoparametric Elements for Cross Sectional Properties and Stress Analysis of Beams*, Surana, K.S, Int. J. for Num. Methods in Engng. Vol 14, 1979.
6. *Introduction to the theory of thin walled structures*, Murray, N.W, Clarendon Press, Oxford, 1984.
7. *Eurocode 2: Design of concrete structures*, 1991.
8. *Introduction to Eurocode 2*, D. Beckett and A. Alexandrou, 1997.
9. *Designers' Handbook to Eurocode 2*, A.W. Beeby and R.S. Narayanan, 1995.
10. *Heurisztikus algoritmusok a sík végelem hálózat csomóponti koordinátáinak optimális megválasztására*, article in the 1998/1-2 issue of the Hungarian scientific magazine *Építés-, Építészettudomány*; Dr. Kirchner István.
11. *Sík végelem hálózat sűrítési eljárása*, article in the 1998/1-2 issue of the Hungarian scientific magazine *Építés-, Építészettudomány*, Dr. Kirchner István.
12. *Eurocode 2: Design of concrete structures, Part 1-1: General rules and rules for buildings.*
13. *Eurocode 3: Design of steel structures, Part 1-1: General rules and rules for buildings; Part 1-5: Plated structural elements.*
14. *Eurocode 8: Design of structures for earthquake resistance, Part 1: General rules, seismic actions and rules for buildings.*

