

StruSoft

Structural Design Software

StruSoft StruXML Revit Add-In

Manual: Using Revit – FEM-Design link

StruSoft AB
Fridhemsvägen 22
SE-217 74, Malmö, Sweden
www.strusoft.com

Version: January 4th, 2017

Copyright

Copyright© 2017 by StruSoft. All rights reserved.

Content of this publication may not be reproduced or transmitted in any means without the written permission of Structural Design Software in Europe AB.

Trademarks

FEM-Design ® is a registered trademark of StruSoft. Revit ® is a registered trademark of Autodesk.

Disclaimer

The StruSoft StruXML Revit Add-In is a tool that enables a link between Revit and FEM-Design. However, the user must understand the assumptions and restrictions that are described in this document.

Considerable time and effort have gone into development and testing of the StruSoft StruXML Revit Add-In. We have done our best to ensure the reliability of the software and the accuracy of this document. However, the user must accept that no warranty is given by the developers or distributors concerning accuracy of this software or information found in this document.

Anyone that has doubts concerning the accuracy of the StruSoft StruXML Revit Add-In, or has suggestions regarding development of the StruSoft StruXML Add-In, is welcome to contact us at: iwona.budny@strusoft.com.

For support, please use: support.femdesign@strusoft.com. When sending support question, please remember to always attach an original Revit / FEM-Design model, struxml file, and in case of Import to Revit – a Revit rvt file, as well us explain which version of FEM-Design and StruSoft StruXML Revit Add-In have been used.

Current link versions

- For FEM-Design 16
 - StruSoft StruXML Revit 2016 Add-In 1.1.008
 - StruSoft StruXML Revit 2017 Add-In 1.1.008

Compatibility

- Revit/Revit Structure: version 2016 and 2017

Download

- [FEM-Design Download Center](#)
- StruSoft Installer

Tutorials and Tips and tricks

- [FEM-Design – Revit Integration](#)
- [StruSoft blog](#)
- [StruSoft Official YouTube channel](#)
- [Discussion forum](#)

Table of contents

I.	INTRODUCTION.....	1	7.2.	BAR ELEMENTS	46
II.	TOOLS	2	7.3.	SHELL ELEMENTS.....	47
1.	ANALYTICAL MODEL	2	7.4.	PROFILED PANELS	47
2.	MATERIAL.....	4	7.5.	FOUNDATIONS	48
3.	CONNECTION STATUS.....	5	7.6.	SUPPORTS	49
III.	WORKFLOW: REVIT TO FEM-DESIGN	6	7.7.	LOADS AND LOAD CASES.....	50
4.	DATA EXCHANGE SCOPE.....	6	8.	IMPORT FEM-DESIGN MODEL TO REVIT	51
4.1.	STRUCTURAL COLUMNS AND FRAMING ELEMENTS.....	6	8.1.	REQUIREMENTS:.....	51
4.2.	STRUCTURAL FLOORS	7	8.2.	EXPORT FEM-DESIGN MODEL TO STRUXML FILE	51
4.3.	STRUCTURAL WALLS.....	8	8.3.	IMPORT STRUXML FILE TO REVIT	51
4.4.	STRUCTURAL FOUNDATIONS	9	8.4.	MAPPING	54
4.5.	MATERIAL.....	11	8.5.	WARNINGS AND ERRORS	58
4.6.	ECCENTRICITY IN SHELL ELEMENTS	11			
4.7.	ECCENTRICITY IN BEAMS	14			
4.8.	RELEASES OF LINEAR ELEMENTS	15			
4.9.	BOUNDARY CONDITIONS.....	16			
4.10.	GRIDS.....	17			
4.11.	LEVELS.....	18			
4.12.	LOADS AND LOAD CASES	18			
5.	EXPORT FROM REVIT TO FEM-DESIGN	23			
5.1.	EXPORT TAB	24			
5.2.	MATERIALS MAPPING.....	26			
5.3.	SECTIONS MAPPING	29			
5.4.	EXPORT UNMAPPED SECTIONS	31			
5.5.	WARNINGS AND ERRORS	34			
5.6.	EXPORT REPORT	38			
5.7.	OPEN STRUXML	42			
6.	LIMITATION AND RECOGNIZED ISSUES	42			
IV.	WORKFLOW: FEM-DESIGN TO REVIT	45			
7.	DATA EXCHANGE SCOPE.....	45			
7.1.	DATUM ELEMENTS.....	45			

I. Introduction

The transfer of data between Revit and FEM-Design is possible thanks to the StruSoft StruXML Revit Add-In. Data are saved into a struxml format and the file is exchanged between Revit and FEM-Design. It is not required that both Revit and FEM-Design are installed at the same computer.

Direction: Revit to FEM-Design

- Export a Revit analytical model to create a new model in FEM-Design.

Direction: FEM-Design to Revit

- Import a FEM-Design model to create a new model in Revit.



Manual scope

This document describes the concept behind the link between Revit and FEM-Design and explains how to exchange data between those two programs using the StruSoft StruXML Revit Add-In.

The manual is divided into two main parts, each dealing with one particular direction of data exchange. Each part contains description of elements and features that can be transferred, as well as explanation of the transfer procedure.

Installation

Download the latest version of StruSoft StruXML Revit Add-In, close Revit and run the installation file. After completion of the installation process, StruSoft tab will appear in Revit as shown in Figure I-1.

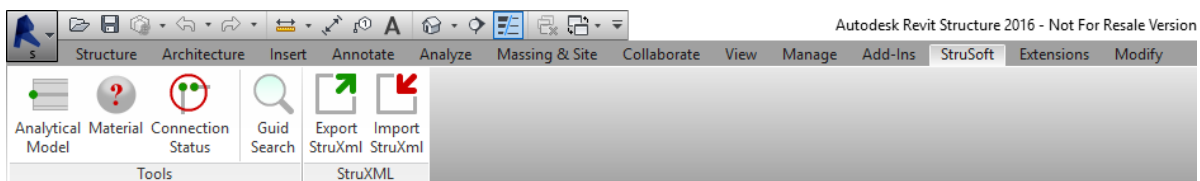

Figure I-1

II. Tools

There are three tools available in the StruSoft tab, in the Tools panel. The tools are helpful in preparation of the Revit model before the export, and are sort of “shortcut” for actions that can be done manually in Revit.

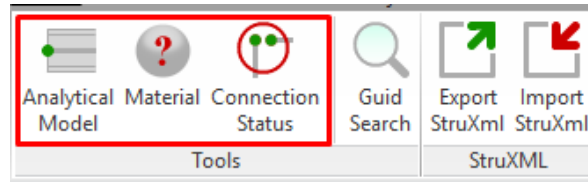

Figure II-1

It is important to understand that the tools do not bring any new functionality to Revit, but only use the existing Revit functions.

1. Analytical Model

Click on *Analytical Model* tool in order to check if all structural objects in your model have analytical model enabled. *Analytical model check* dialog will appear with a list of all objects without analytical model, as shown in figure below (if all objects in your model have analytical model enabled, the list will be empty).

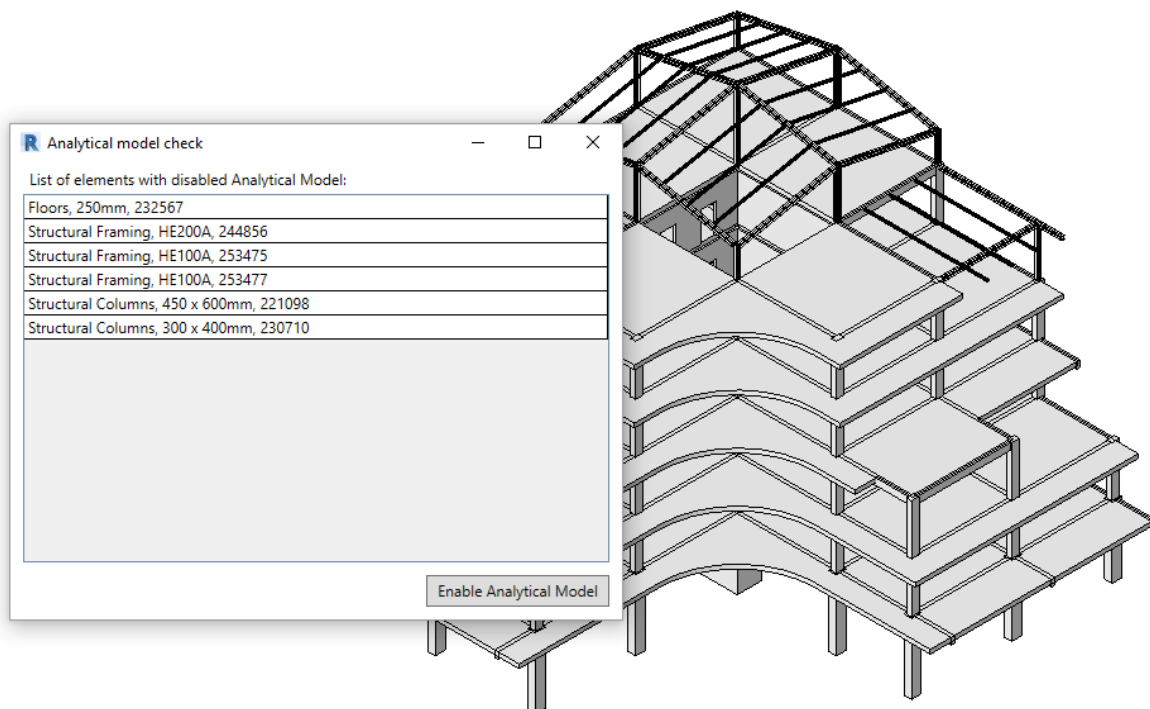

Figure II-2

This tool gives you the following options:

- Double click on one element to highlight it in the model.

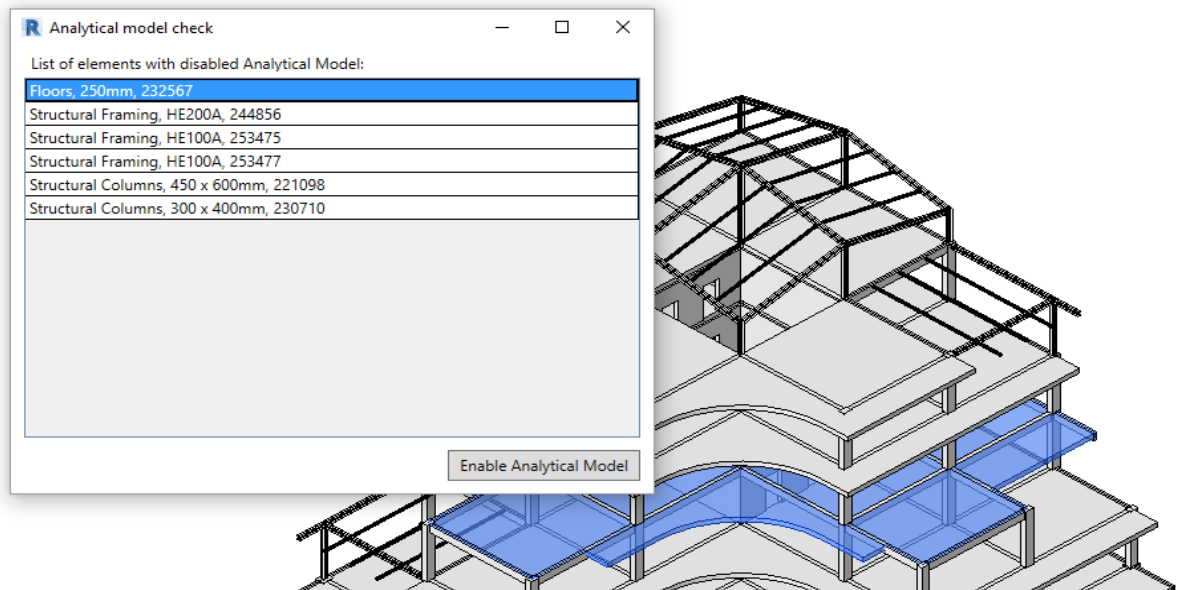

Figure II-3

- Select one or more elements (with Ctrl button) and right click, chose *Isolate selected* to isolate them in a view.

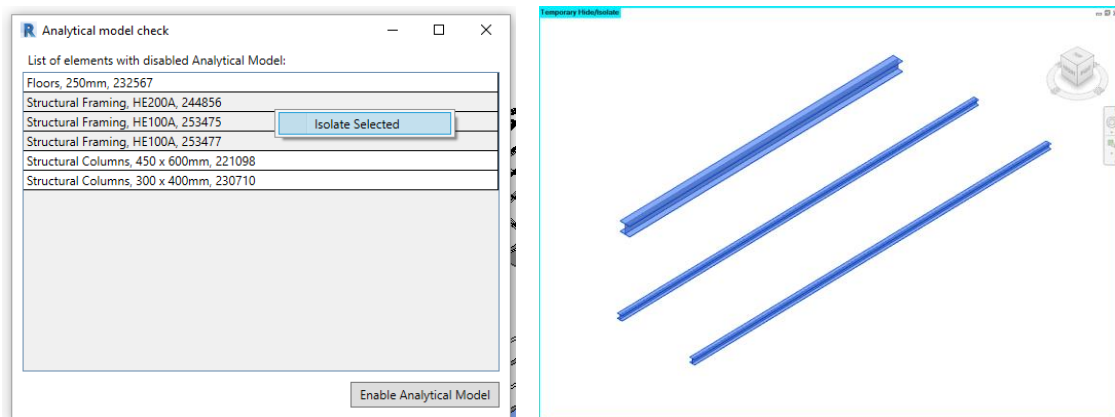

Figure II-4

Close the *Analytical model check* dialog in order to modify the objects in the *Temporary Hide/Isolate* view. To close the view click on *Reset Temporary Hide/Isolate*.

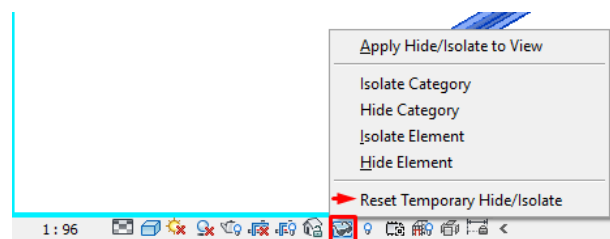

Figure II-5

- Select one, more elements (with Ctrl button), or all elements (Ctrl + A) and press *Enable Analytical Model* in order to enable the analytical model in the selected objects. If the analytical model is enabled in all elements, the dialog becomes empty.

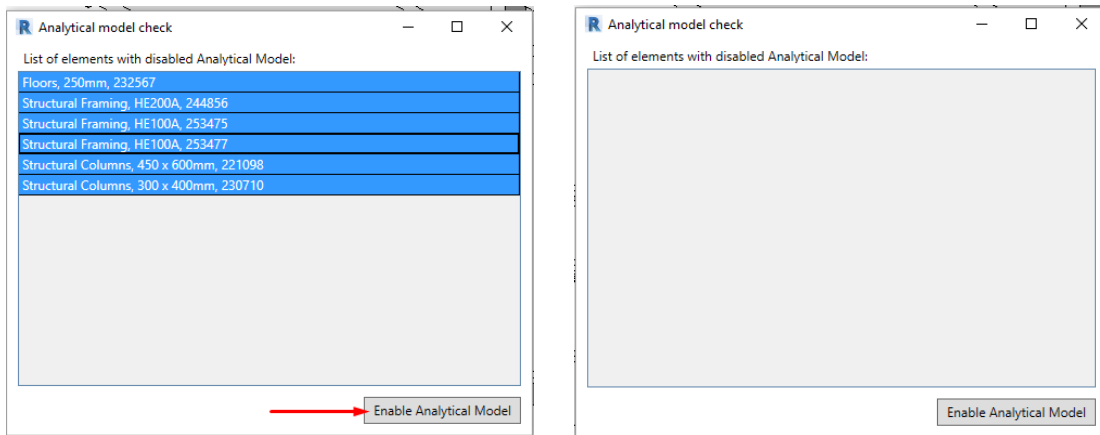

Figure II-6



In case of larger number of elements without the analytical model, it is recommended to enable it partially to a smaller number of objects at a time, rather than enabling it all at once. It requires smaller regeneration of the Revit model and will speed the process up.

2. Material

Click on *Material* tool in order to check if all structural objects in your model have valid structural material. *Structural material check* dialog will appear with a list of all objects without valid structural material, as shown in figure below (if all structural objects in your model have valid structural material, the list will be empty).

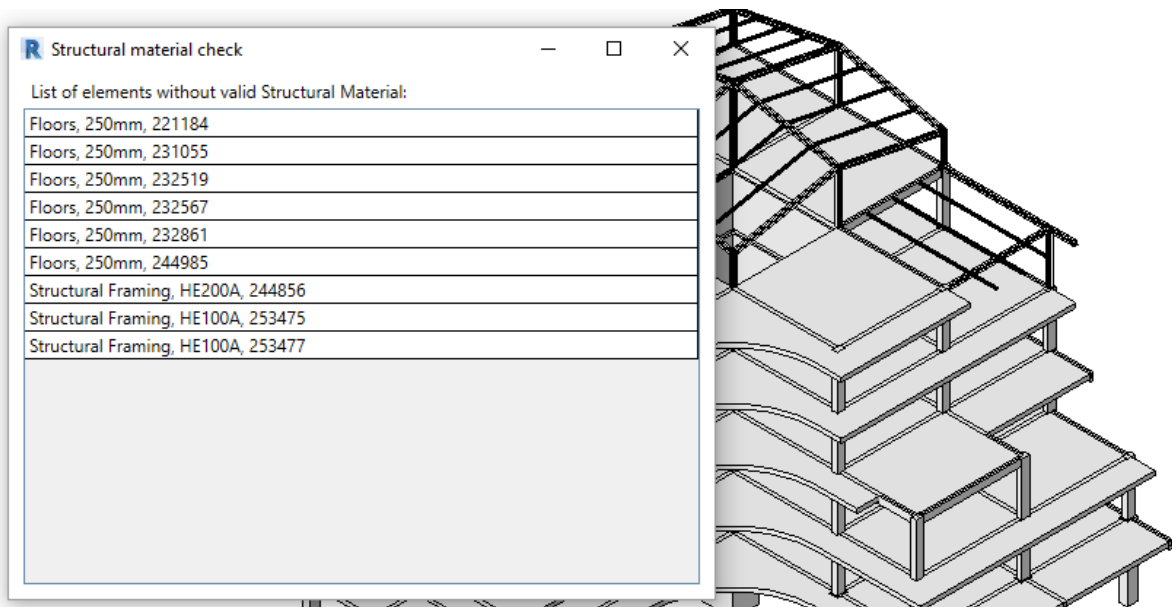

Figure II-7

This tool gives you the following options (partially similar to *Analytical Model* tool):

- Double click on one element to highlight it in the model.
- Select one, more elements (with Ctrl button), or all elements (Ctrl + A) and right click, chose *Isolate selected* to isolate them in a view. Close the *Structural material check* dialog in order to modify the objects (e.g. add the structural material) in the *Temporary Hide/Isolate* view. To close the view click on *Reset Temporary Hide/Isolate*.

3. Connection status

Click on *Connection Status* tool in order to create a view called *Connection Status* that will display the analytical model including analytical nodes that are filtered by their connection status (green node – connected, red node – unconnected).



The view is created as a copy of the current view, so if the displayed view is a 3D model view, a new 3D view of Connection Status will be created. Respectively, if a current view is Structural Plan, then a new structural plan showing the connection status will be created.

If a current view has some view template applied, it may influence creation of the Connection Status view. **It is therefore, recommended to open a default 3D to create a Connection Status view.**

The view shows all available analytical objects (excluding the analytical links, boundary conditions and loads).

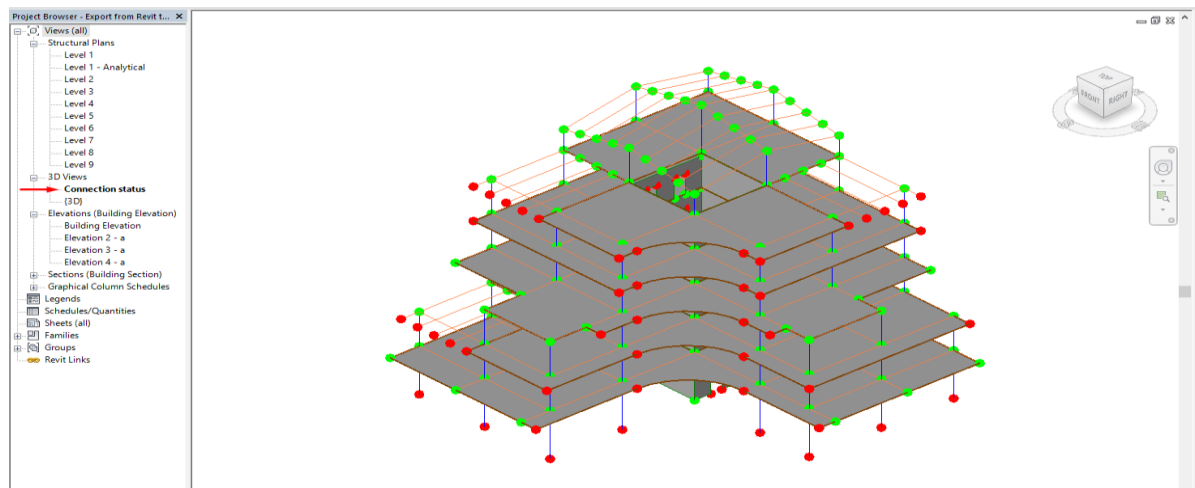

Figure II-8

Two filters are applied to that view in order to distinguish between the connected and unconnected nodes.

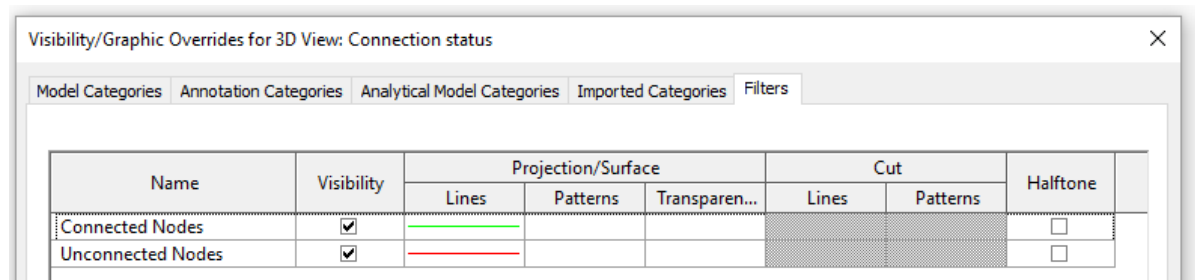

Figure II-9

III. Workflow: Revit to FEM-Design

The transfer of structural elements from Revit to FEM-Design is done by exporting an analytical model of an instance of an element along with its properties, i.e. material, section/profile/thickness, release conditions, eccentricity.



If a structural element in Revit does not have analytical model enabled, it will not be exported to FEM-Design.

4. Data exchange scope

Following elements and properties can be exported from Revit to FEM-Design using the StruSoft StruXML Revit Add-In:

Elements:

- Structural Columns
- Structural Framing elements (Beams, Beam systems, Braces, Trusses)
- Structural Floors
- Structural Walls
- Structural Foundation
- Grids and levels
- Loads and load cases

Properties:

- Material of an element
- Section / Profile / Thickness of an element
- Releases of linear elements
- Boundary conditions
- Eccentricity in case of floor slabs, walls and beams

4.1. Structural columns and framing elements

Following properties of *Structural Columns* and *Structural Framing* elements are exported from Revit to FEM-Design along with the geometry of the *Analytical Column* or *Analytical Beam* element:

- Section / profile
- Material*
- Release conditions
- Eccentricity (only of beams)**

* Only the Structural material is exported. Read more in Chapter 4.5.

** Read more about the eccentricity export rules in Chapter 4.7.

Slanted columns in Revit can be exported to struxml and read in FEM-Design, but a message at the export will appear (both in the Export dialog and in the Export Report) in order to warn about slanted elements in the model, as shown in Figure III-1.

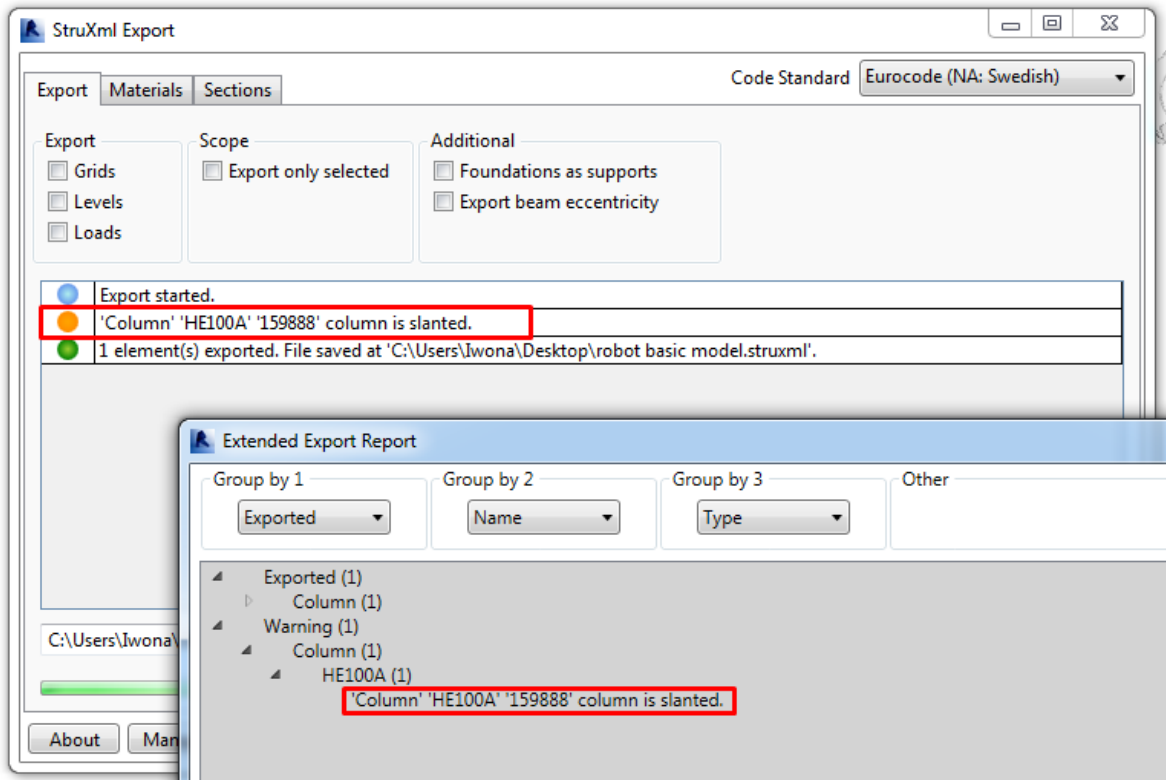

Figure III-1

4.2. Structural floors

Following properties of *Structural Floors* are exported from Revit to FEM-Design along with the geometry of the *Analytical Floor* element:

- Thickness of the structural layer
- Material*
- Eccentricity**



If one wants to export a Revit model containing floor elements, he needs to be aware that each structural floor element in Revit has to be a separate instance i.e. only one individual floor should be drawn using the *Create Floor Boundary* command.

If more than one floor element is created within one floor boundary (as shown in Figure III-2), it will be divided into number of separate elements when exported to struxml.

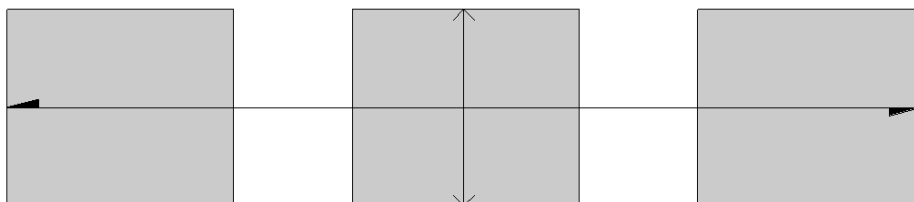

Figure III-2

* Only the Structural material is exported. Read more in Chapter 4.5.

4.3. Structural walls

Following properties of *Structural Walls* are exported from Revit to FEM-Design along with the geometry of the *Analytical Wall* element:

- Thickness of the structural layer
- Material*
- Eccentricity**

* Only the Structural material is exported. Read more in Chapter 4.5.

** Read more about the eccentricity export rules in Chapter 4.6.

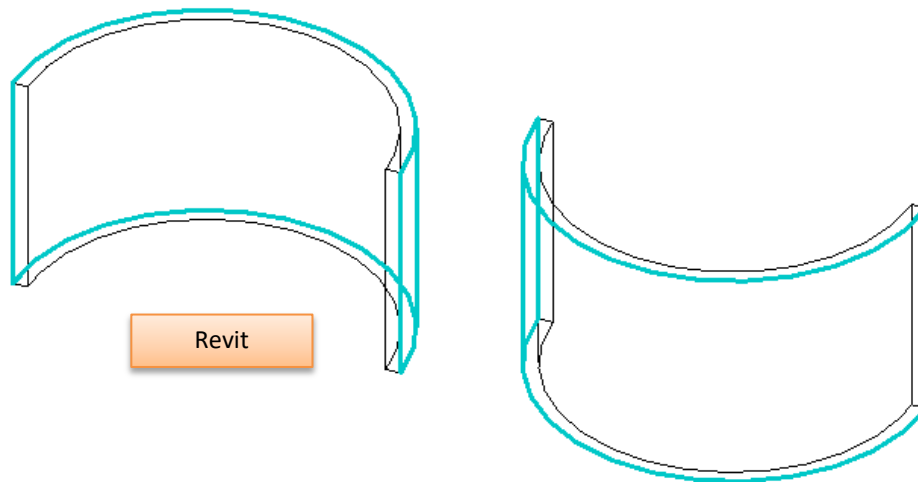

Figure III-3



Curved walls drawn in Revit (Figure III-3) will be divided into a number of straight walls while being exported to struXML file, as shown in Figure III-3. This is the way curved walls are represented in FEM-Design.

Figure III-4 shows the convention of the local coordinate system that curved walls will be assigned with in FEM-Design.

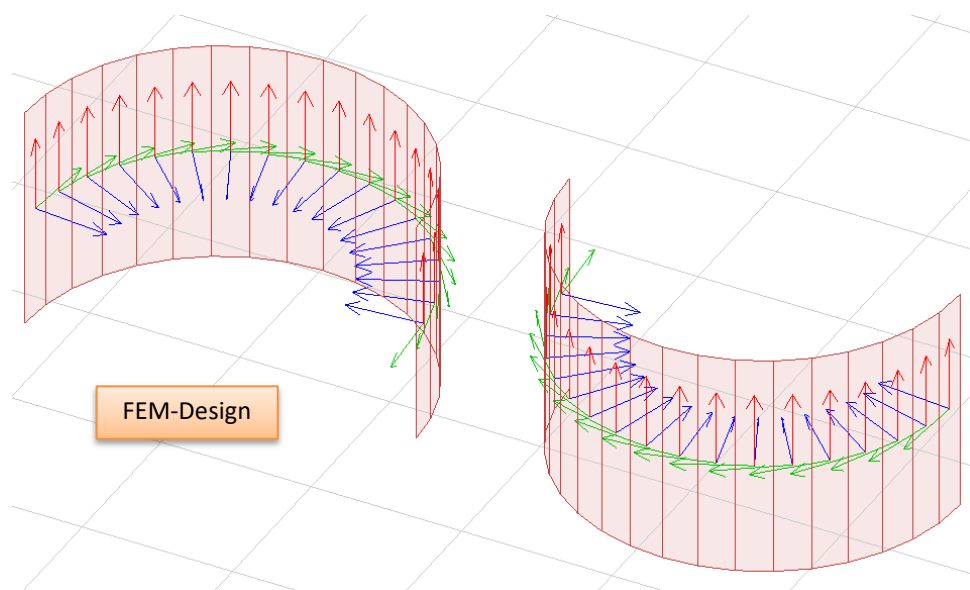

Figure III-4

4.4. Structural Foundations

User can decide if to export *Structural Foundations* as supports or as foundation elements. By default, foundations are always exported as foundation elements. The option to export foundations as supports is present in the *StruXML Export* dialog as shown in Figure III-5.

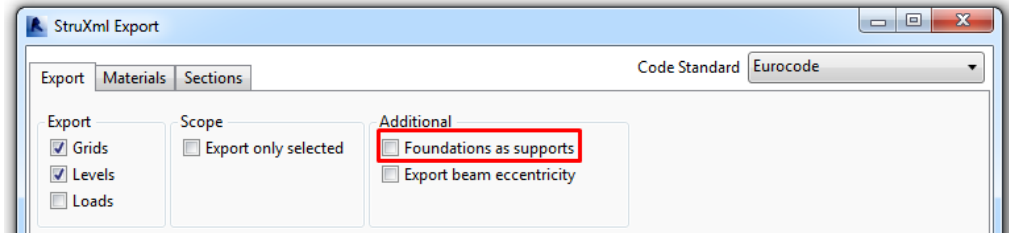

Figure III-5



Structural Foundations can be exported as foundation elements only to FEM-Design in version higher than 12.00.003

4.4.1. Export as foundation elements

If *Foundation as Supports* option is not selected, *Structural Foundations* will be exported from Revit to FEM-Design as foundation elements according to the following manner:

Structural Foundation: Isolated

It is exported to FEM-Design as *Isolated foundation* with the following default settings:

- Analytical system: Point support group
- Bedding modulus: 10000 kN/m²/m

An analytical model of isolated foundation is exported to FEM-Design along with the material properties and the exact position of the physical model in respect to the analytical model (In FEM-Design recognized as *Connection point*) as shown in Figure III-6.

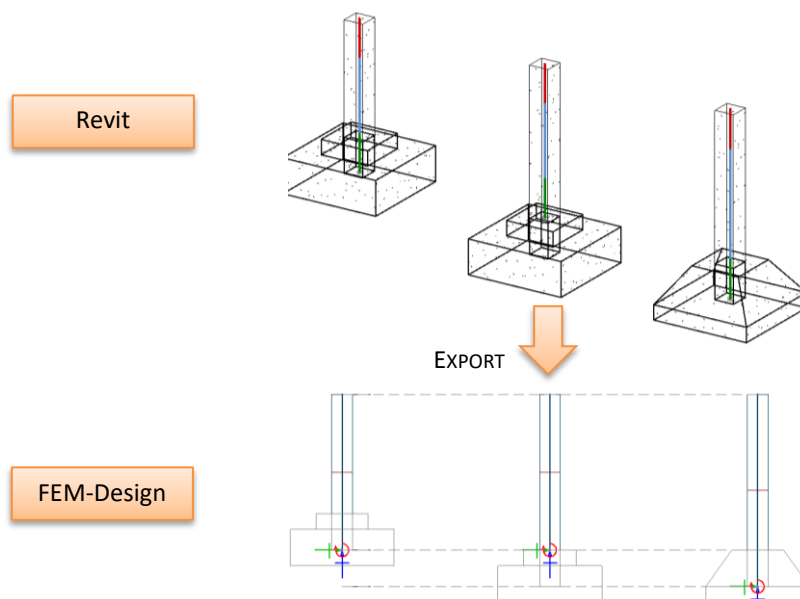

Figure III-6



it is only possible to export the geometry of foot pads with non-curved edges. All the other kinds of isolated foundations, i.e. foot pads with round edges, piles, pile caps, etc. will be exported as a *Point Support group* with the default state *Hinged*. The point support will be added in each analytical foundation (point).

Structural Foundation: Wall

It is exported to FEM-Design as *Wall foundation* with the following default settings:

- Analytical system: Line support group
- Bedding modulus: 10000 kN/m²/m

An analytical model of wall foundation is exported to FEM-Design along with the material properties and the exact position of the physical model in respect to the analytical model (in FEM-Design recognized as *Insertion point*) as shown in figure below.

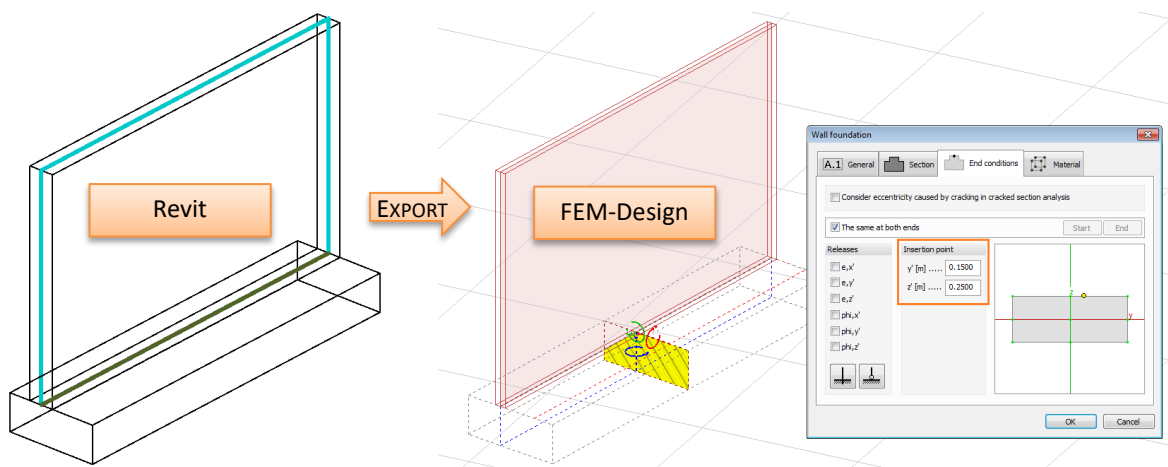

Figure III-7

Structural Foundation: Slab

It is exported to FEM-Design as *Foundation slab* with the following default settings:

- Bedding modulus: 10000 kN/m²/m

An analytical model of slab foundation is exported to FEM-Design along with the material properties and the analytical alignment definition. Read about the analytical alignment rules in Paragraph 4.6.

4.4.2. Export as supports

If *Foundation as Supports* option is selected, *Structural Foundations* are exported from Revit to FEM-Design as *Supports* according to the following manner:

- *Structural Foundation: Isolated* in FEM-Design will be converted into *Point Support Group* with the default type: *Hinged*
- *Structural Foundation: Wall* in FEM-Design will be converted into *Line Support Group* with the default type: *Hinged*
- *Structural Foundation: Slab* in FEM-Design will be converted into a *Surface support group*.

4.5. Material

Each analytical element that is meant to be exported from Revit to FEM-Design needs to have a structural material assigned to its physical model.



Element, which structural material is set to be *<By Category>* will not be exported to FEM-Design. An error about lack of structural material assigned to an element will appear after attempt to export such element. **<-- Read about recognized issue in Chapter 6.**

In case of multilayer walls or multilayer floor slabs, analytical model is exported along with the material (and thickness) property of a layer that is marked as a *Structural Material*. In the example shown in Figure III-8, the wall element would be exported from Revit to FEM-Design as a 215 cm thick element with the material: *Masonry – Concrete Block*.

LAYERS						
EXTERIOR SIDE						
	Function	Material	Thickness	Wraps	Structural Material	
1	Finish 1 [4]	Brick, Common	102.0	<input checked="" type="checkbox"/>	<input type="checkbox"/>	
2	Thermal/Air Layer [3]	Cavity Fill	50.0	<input checked="" type="checkbox"/>	<input type="checkbox"/>	
3	Membrane Layer	Vapour Retarder	0.0	<input checked="" type="checkbox"/>	<input type="checkbox"/>	
4	Core Boundary	Layers Above Wrap	0.0	<input type="checkbox"/>	<input type="checkbox"/>	
5	Structure [1]	Masonry - Concrete	215.0	<input type="checkbox"/>	<input checked="" type="checkbox"/>	
6	Core Boundary	Layers Below Wrap	0.0	<input type="checkbox"/>	<input type="checkbox"/>	
7	Finish 2 [5]	Finishes - Interior -	12.0	<input checked="" type="checkbox"/>	<input type="checkbox"/>	

INTERIOR SIDE

Figure III-8

4.6. Eccentricity in shell elements

In Revit user can decide about the position of *Analytical Wall* and *Analytical Floor / Analytical Foundation Slab* in relation to the physical model. Those settings are exported to FEM-Design as *Eccentricity* and the Alignment is set to one of the three values: Top/Left, Center or Bottom/Right. Example of an alignment setting in case of floor element is shown in Figure III-9.

Figure III-9

4.6.1. Analytical Floor / Analytical Foundation Slab

Following *Analytical Alignment* definition of an *Analytical Floor / Analytical Foundation Slab* is exported to FEM-Design:

Alignment Method: Projection
 z Projection: Top of Slab
 Center of Slab
 Bottom of Slab

In any other case, i.e. *Projection* is set to a *Level* or a *Reference Plane*, or the *Alignment Method* is set to be *Auto detect*, the default position of *Analytical Floor / Analytical Foundation Slab* in relation to physical element after export to FEM-Design will be: *Center*.

Example of different settings in Revit and the final result after opening the exported model in FEM-Design is shown in Table III-1 and in Figure III-10.

	1	2	3	4	5
Revit Alignment:	Projection	Projection	Projection	Projection	Auto detect
Method:	Top of Slab	Center of Slab	Bottom of Slab	Level 1	-
Corresponding FEM-Design alignment	Top/Left	Center	Bottom/Right	Center	Center

Table III-1

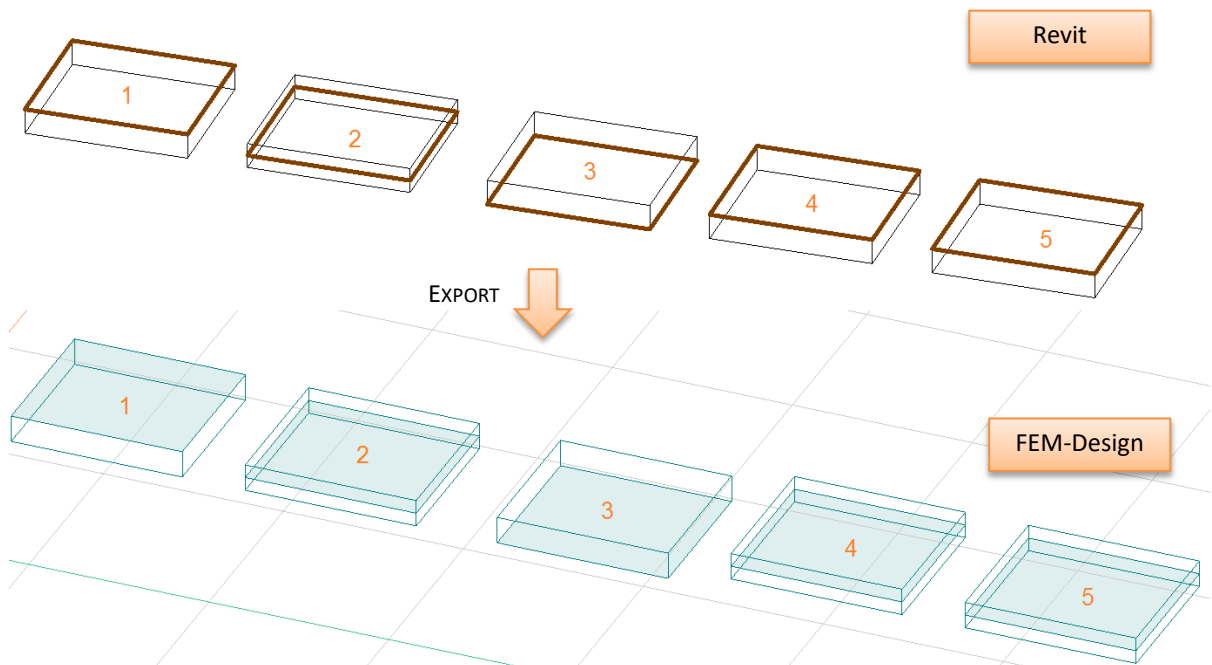

Figure III-10

4.6.2. Analytical Wall

Following *Analytical Alignment* settings of an *Analytical Wall* are exported to FEM-Design:

Alignment Method: Projection
 Projection: Center of Element
 Interior Face
 Center of Core
 Exterior Face

In any other case, i.e. *Projection* is set to a *Grid* or a *Reference Plane* or the *Alignment Method* is set to be *Auto detect*, the default position of analytical model in relation to physical element after export to FEM-Design will be: *Center*.

Example of different settings in Revit and the final result after opening the exported model in FEM-Design is shown in Table III-2 and in Figure III-11.

	1	2	3	4	5
Revit Alignment Method:	Projection Center of Element	Projection Interior Face	Projection Center of Core	Projection Exterior Face	Auto detect -
Corresponding FEM-Design alignment	Center	Right	Center	Left	Center

Table III-2

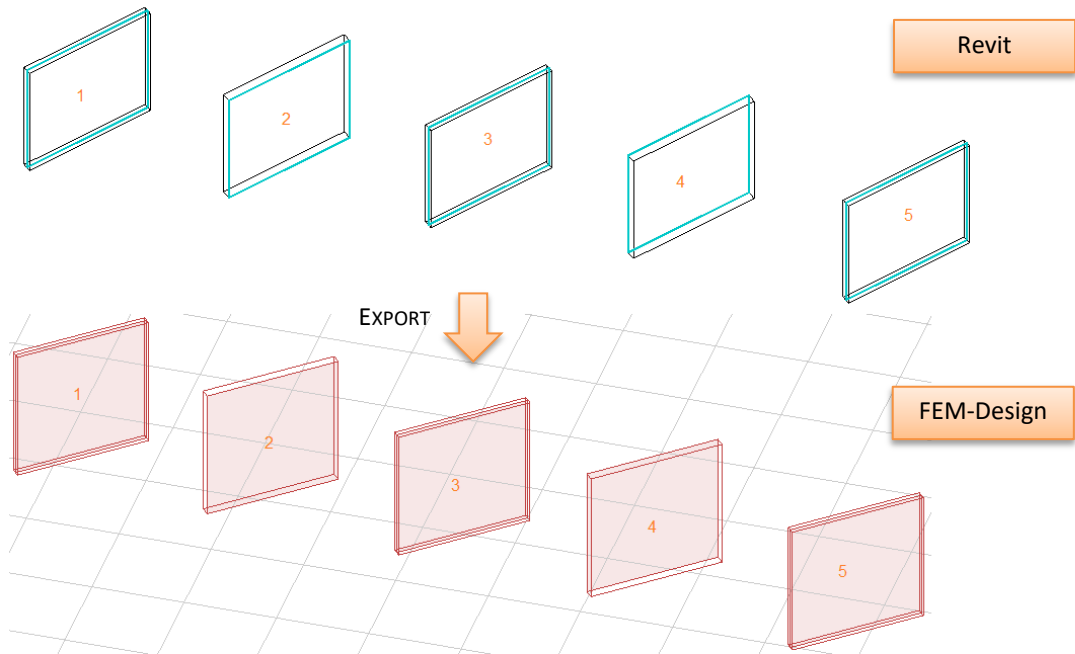

Figure III-11

4.7. Eccentricity in beams

Almost any configuration of analytical beam model in regards to its physical representation can be transferred to struxml and read in FEM-Design as *Eccentricity*.

In order to export physical eccentricity in beams, one has to check the *Export beam eccentricity* box in the *Export StruXML* dialog, as shown in Figure III-12. <-- **Read about recognized issues in Chapter 6.**

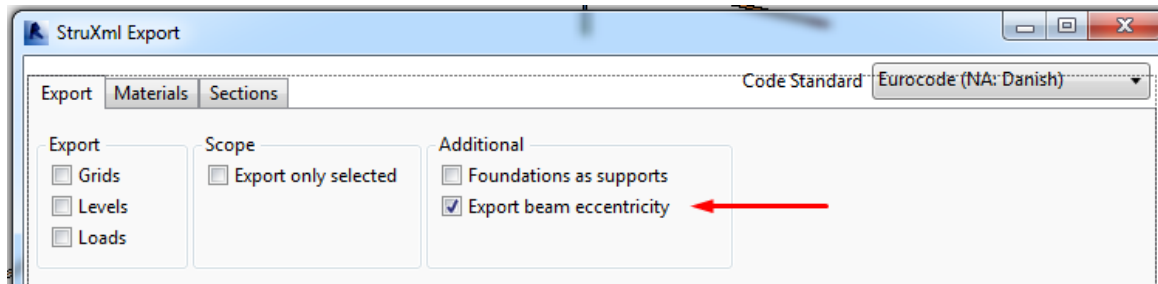

Figure III-12

Example of beam eccentricity export is shown in Figure III-13

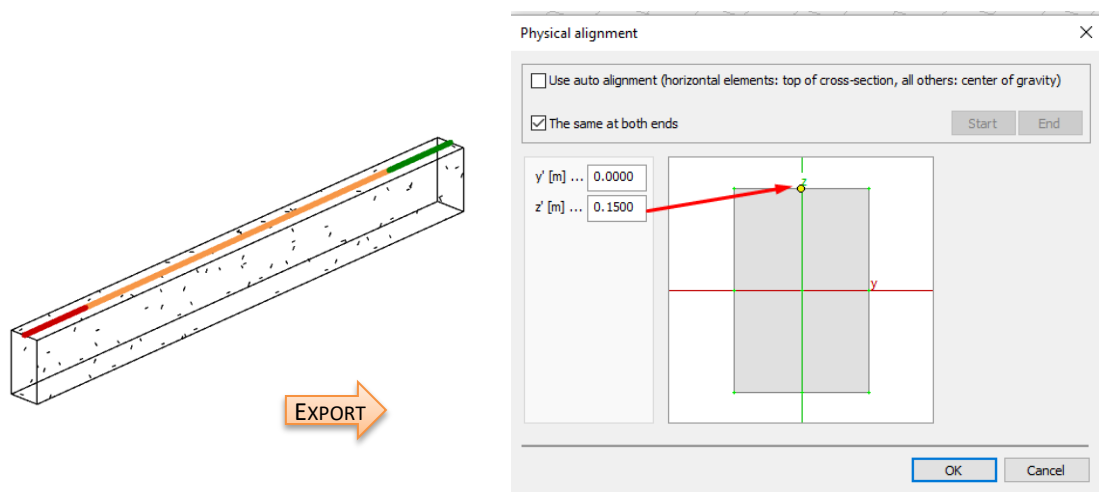

Figure III-13

The eccentricity configuration that cannot be exported to struxml is when the start and end part of the analytical beam are not the same. Example of such configuration is shown in Figure III-14.

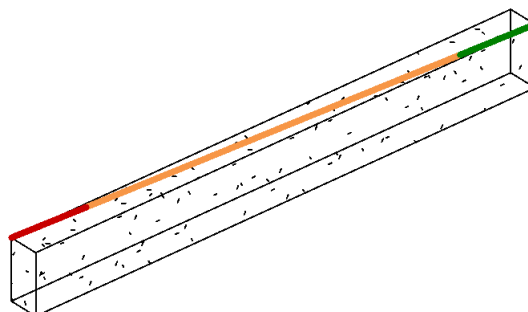

Figure III-14

In this case, a warning will be thrown at the export (Figure III-15).

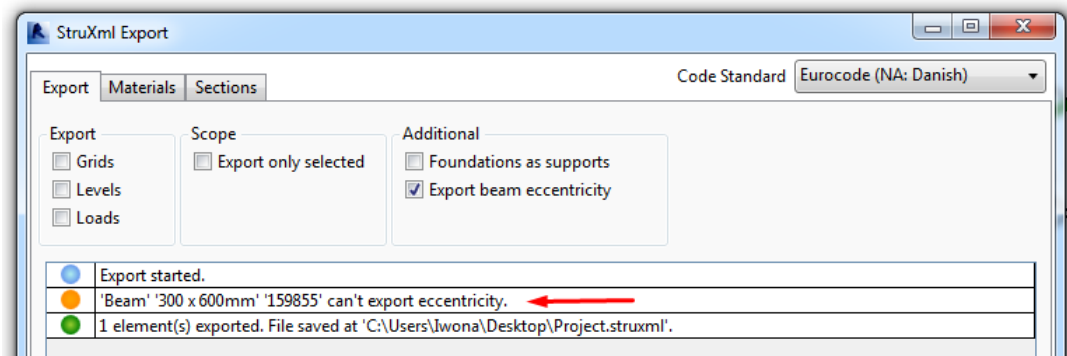

Figure III-15

The analytical position of the beam will be exported to struxml (as usually), but eccentricity will not. It means that the cross section will be simply assigned along the length of the analytical beam, with $y'=0$ and $x'=0$ eccentricity values (Figure III-16).

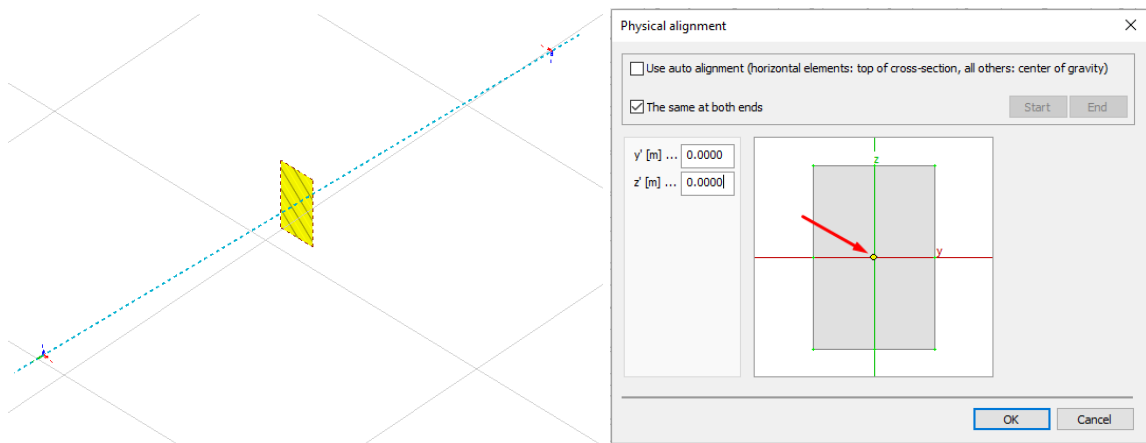

Figure III-16

4.8. Releases of linear elements

All linear analytical elements are exported from Revit to FEM-Design along with the settings of *Top Release* and *Bottom Release*. The exact definition of the three predefined releases: *Pinned*, *Fixed*, *Bending Moment* as well as *User Defined* release are exported to FEM-Design. Figure III-17 shows release conditions originally set in Revit and the result of the export to FEM-Design.

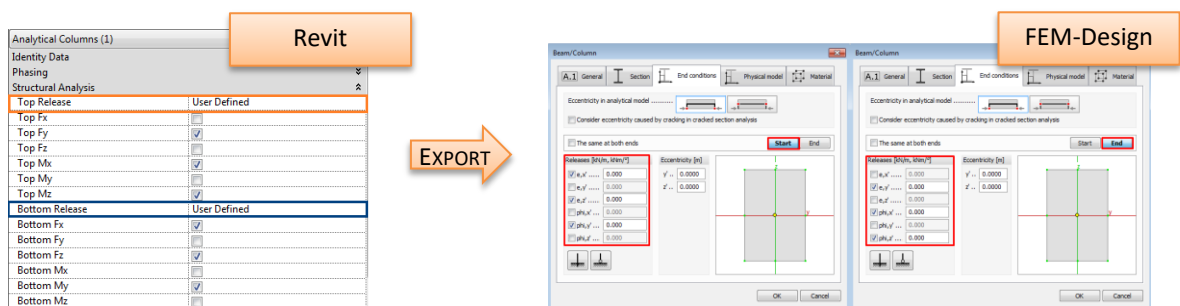

Figure III-17

4.9. Boundary conditions

In Revit, *Boundary Conditions* command allows to choose between three kinds of boundary conditions: *Point*, *Line*, and *Area*. User has to assign it with one of predefined or user defined *State* in X, Y and Z direction: *Fixed*, *Pinned*, *Roller*, and *User*.

The exact definition of boundary conditions can be exported from Revit to FEM-Design as follows:

Boundary Condition Type:

- *Point*: exported to FEM-Design as *Point Support Group*
- *Line*: exported to FEM-Design as *Line Support Group*
- *Area*: exported to FEM-Design as *Surface Support Group*

State:

- *Fixed*: exported to FEM-Design as type *Hinged*
- *Pinned*: exported to FEM-Design as type *Rigid*
- *Roller*: exported to FEM-Design according to Revit definition
- *User*: exported to FEM-Design according to Revit definition

Example: *Point* boundary condition type with the *Pinned* state is exported to FEM-Design as *Point Support Group*, type: *Hinged* as shown in Figure III-18.

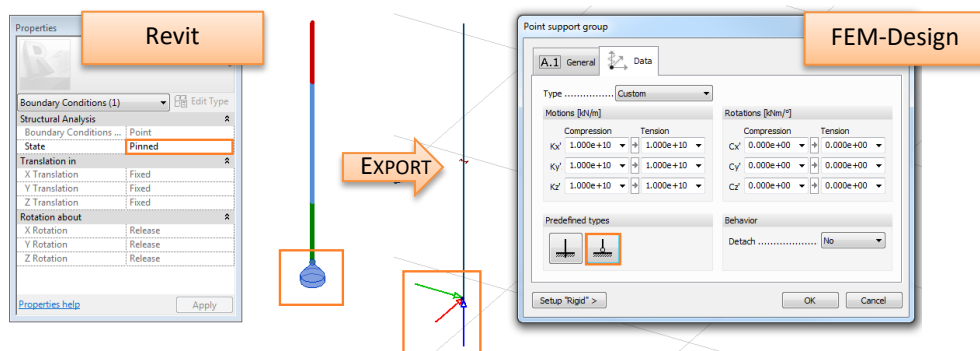

Figure III-18

The “Rigid” value exported from Revit to FEM-Design is equal to: $1e+15$ kN/m for motion, and $3.046e+11$ kNm/° for rotation.

Line boundary conditions under curved walls are special case. Each curved wall exported from Revit, in FEM-Design will be divided into a number of straight walls. But line boundary condition will remain curved, as shown in the left part of the figure below. It is therefore, user’s responsibility to verify the support condition under curved walls in order to obtain a desired solution as shown in the right part in figure below.

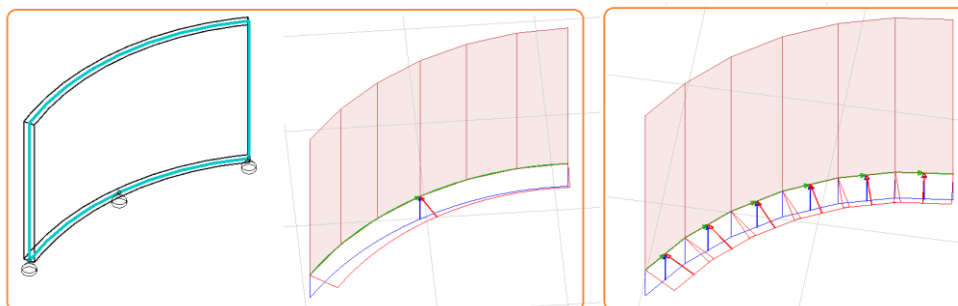

Figure III-19

4.10. Grids

Grids defined in Revit model may be exported to FEM-Design where they will be recognized as *Axes*. *Grids* are exported with following assumptions:

- If the option to *Export Grids* (Figure III-23) is selected, all the grids will be exported to FEM-Design.
- The exact length of the each grid is exported.
- All the grids are always exported into 00.000 m level in FEM-Design.
- Names of the grids are not exported. Each axis in FEM-Design will receive a new number based on the order of grid creation in Revit, as shown in Figure III-20. If necessary, renaming can be performed in FEM-Design.

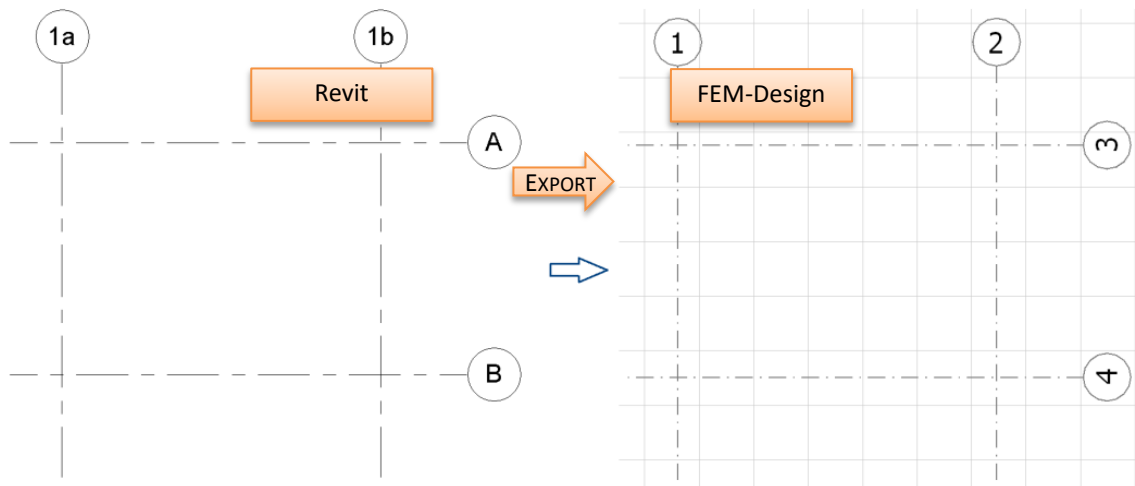

Figure III-20

In FEM-Design only straight line axes are allowed. Therefore,

- *Multi-Segment Grid* after export from Revit to FEM-Design will be replaced with a number of straight line axes equivalent to number of segment.
- curved grid after export from Revit to FEM-Design will be replaced with a straight line axis between the start and end point of the original curved grid, as shown in Figure III-21.

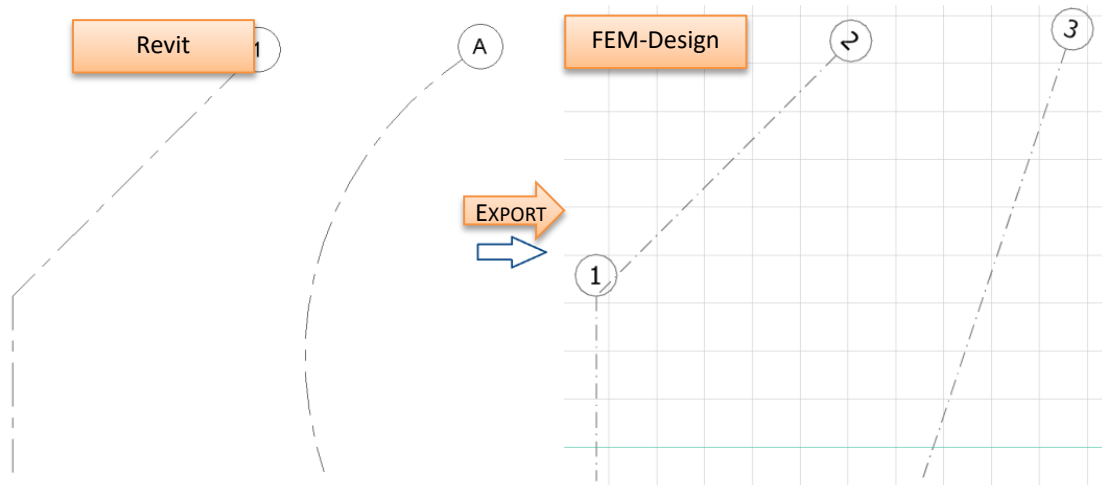

Figure III-21

4.11. Levels

Levels defined in Revit model can be exported to FEM-Design, where they will be recognized as Storeys.

Levels are exported with following assumptions:

- If the option to *Export Levels* is selected (Figure III-23), all the levels will be exported to FEM-Design.
- Name of the levels are exported to FEM-Design.
- Size of the *Storey* in FEM-Design is calculated based on the placement of most outer elements in the Revit model and included as a *Horizontal size of building* in the *Storey* dialog, as shown in Figure III-22.
- *Levels* cannot be exported if no elements are created in the Revit model because size of a storey cannot be generated.

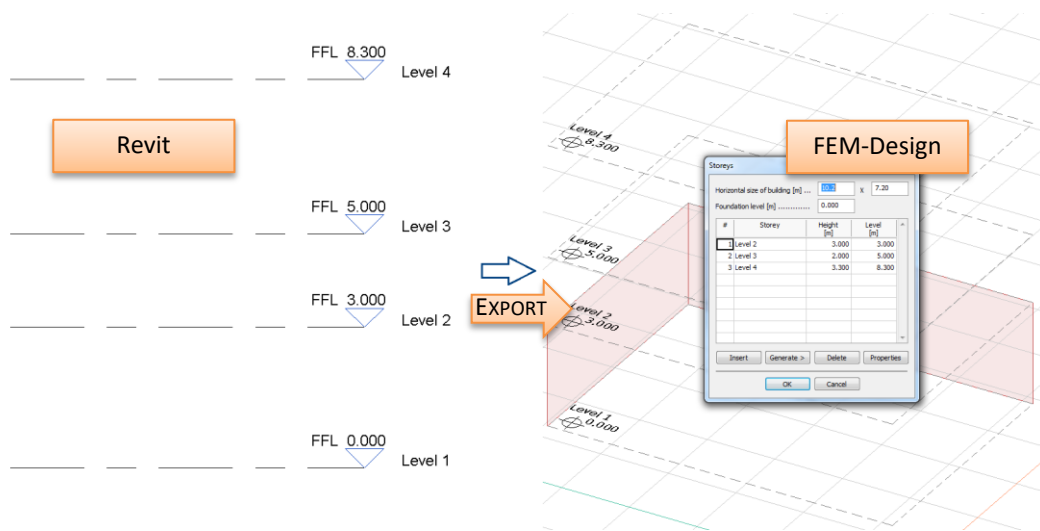

Figure III-22

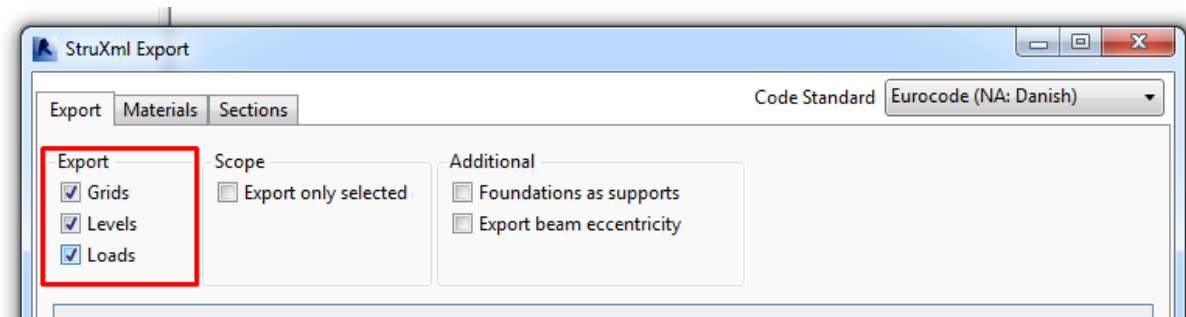

Figure III-23

4.12. Loads and load cases

In order to export loads and load cases one should select the *Loads* to be exported in the *StruXml Export* dialog, as shown in Figure III-23.

4.12.1. Load cases

If the *Export Loads* option is selected, all *Load Cases* existing in Revit will be exported to FEM-Design (including those loads cases that do not contain any loads assigned).

The only property of the load case that is exported from Revit to FEM-Design is a *Name*. Definition of *Nature* and *Category* is not relevant for the export to FEM-Design.

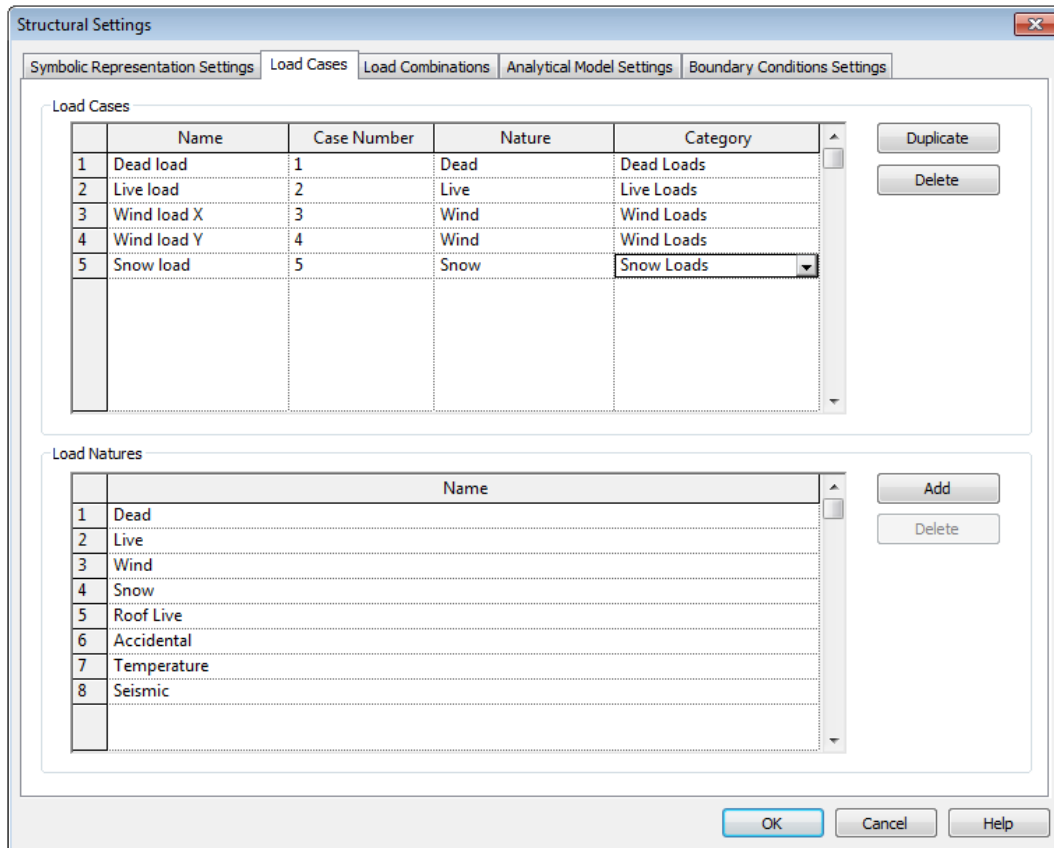

Figure III-24

Each of the *Load Cases* exported from Revit, in FEM-Design will be assigned with the *Type: Ordinary* that is suitable to any kind of load nature.

Example of loads cases defined in Revit (Figure III-24) and exported to FEM-Design is shown in Figure III-25.

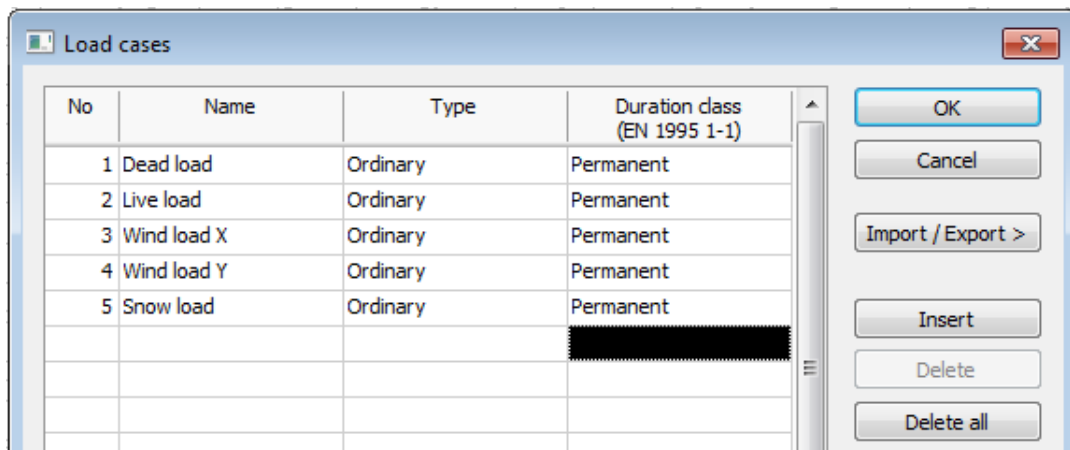

Figure III-25



It is user's responsibility to decide which of the cases will additionally contain self-weight of structural elements. It can be done by changing the load case *Type* from *Ordinary* to *+Struc. Dead load*.

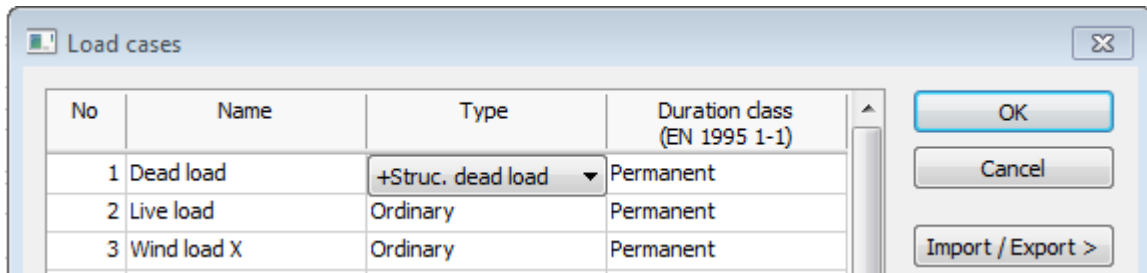

Figure III-26

4.12.2. Loads

Following *Load* types are exported from Revit to FEM-Design:

- Point Load
- Line Load
- Area load
- Hosted Point Load
- Hosted Line Load
- Hosted Area load

The example on how the loads are exported from Revit to FEM-Design is shown in following Figures.

Figure III-27 shows a vertical force of 1kN is applied to a column in Revit. The value of the force is -1kN so the force acts downward. The force is applied into a load case: *Dead load*.

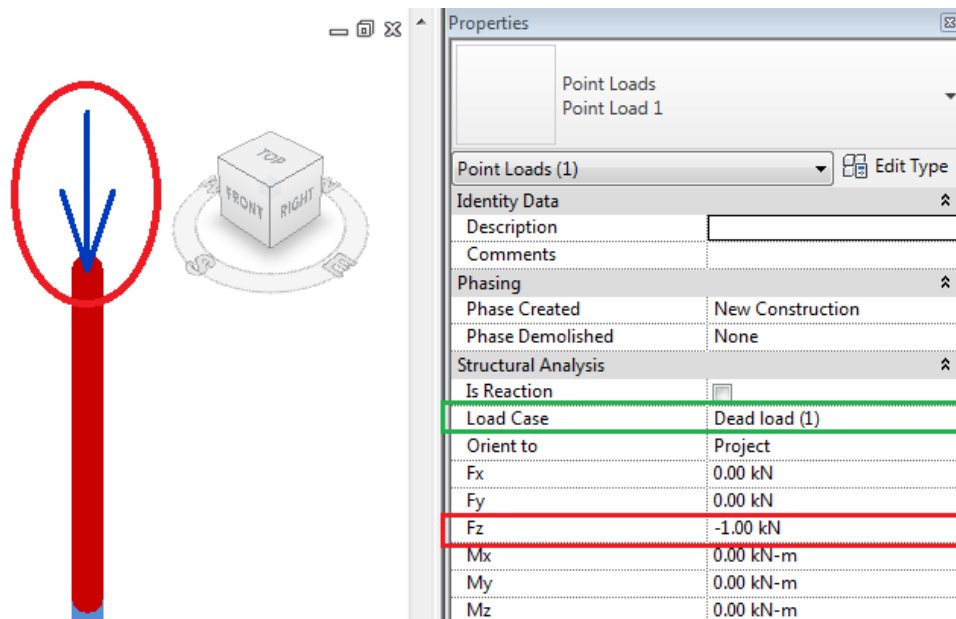

Figure III-27

Figure III-28 shows how the model looks like after exporting it to FEM-Design.

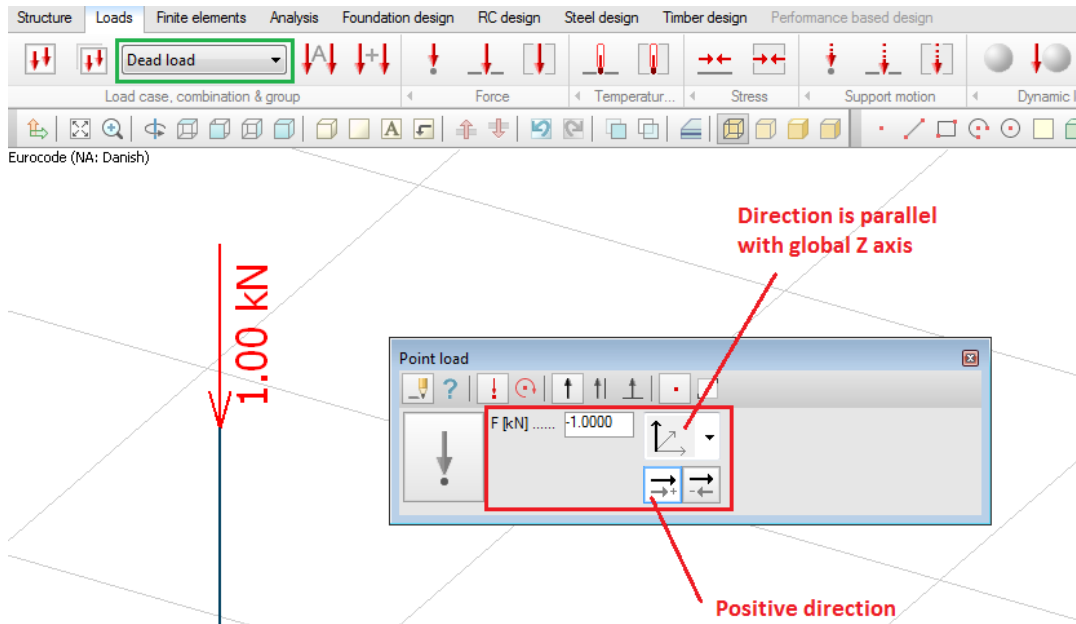

Figure III-28

The load value is -1 kN , as defined in Revit. The correct direction of the load is preserved by setting a positive direction (with the global Z axis) that is consistent with the positive direction of Revit coordinate system. The load is assigned to a corresponding load case *Dead load*.

If more force components is assigned into one point load or one surface load, the visible force in Revit will be displayed as resultant force, as shown in Figure III-29.

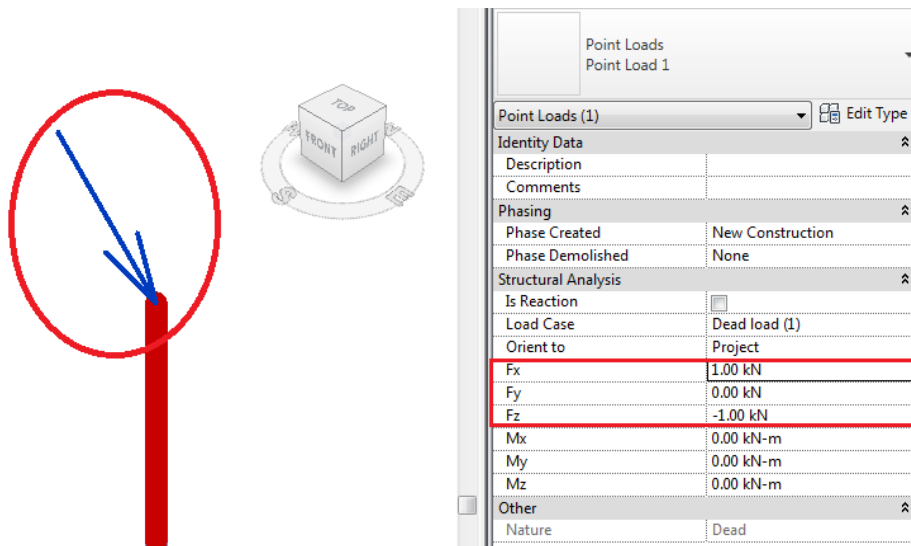

Figure III-29

After exporting it to FEM-Design, the point (or surface load) will be divided into separate components. So, the column from figure above will be loaded with a force of 1kN acting in the X – direction, as shown in Figure III-30.

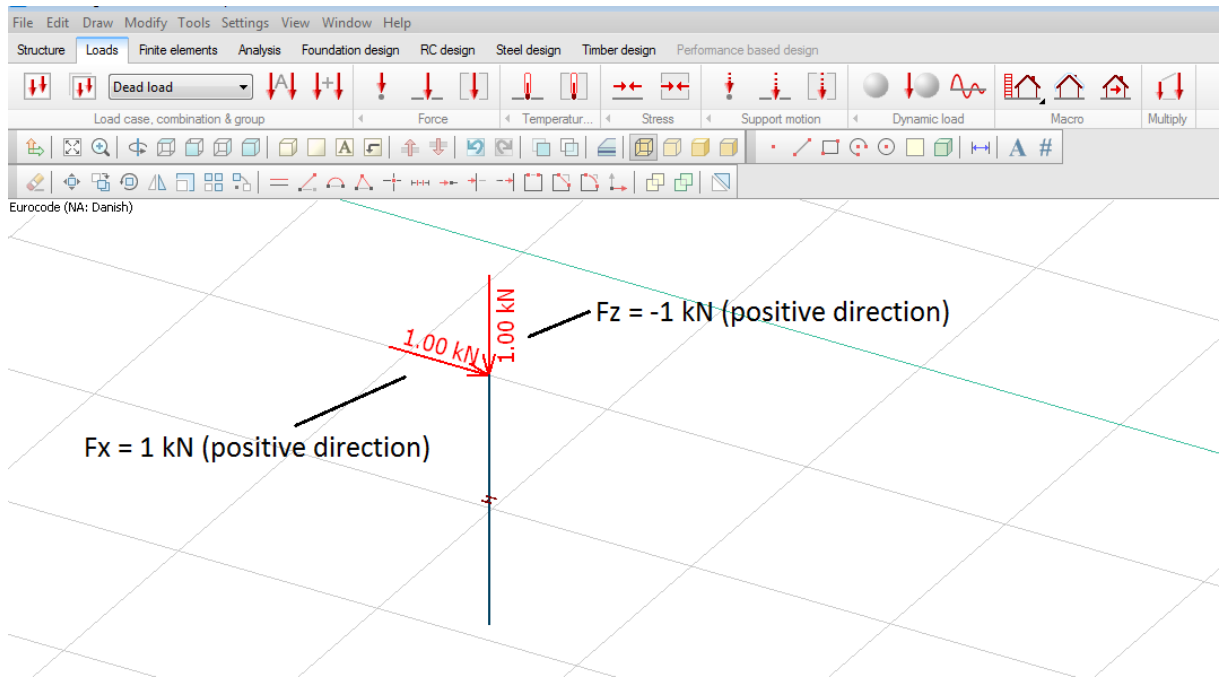

Figure III-30

5. Export from Revit to FEM-Design

Before exporting a model from Revit to FEM-Design, make sure that:

- all the elements you wish to export have analytical model enabled,
- the analytical model of the structure is consistent and is arranged the way you want it to be exported to FEM-Design,
- all the elements you wish to export have a structural material assigned.

If the analytical model is prepared, proceed with the *Export StruXML* command that is placed in the *StruXML panel* in the *StruSoft* tab in Revit.

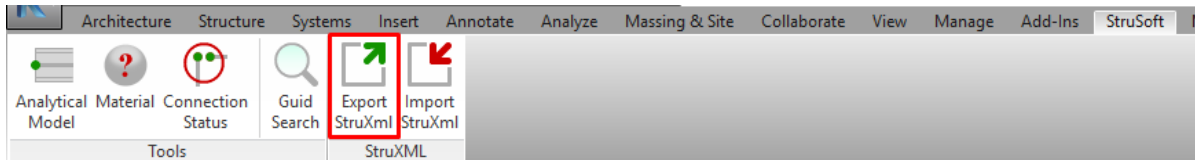

Figure III-31

Upon choosing the *Export StruXML* command, a *Code* dialog shown in Figure III-32 will appear. Before exporting model to FEM-Design, it is necessary to select one of the design codes. Chosen code and national annex will influence the material and sections library that will be used for mapping. After choosing the desired code standard, check *Set as default* box, if you want to save this choice.

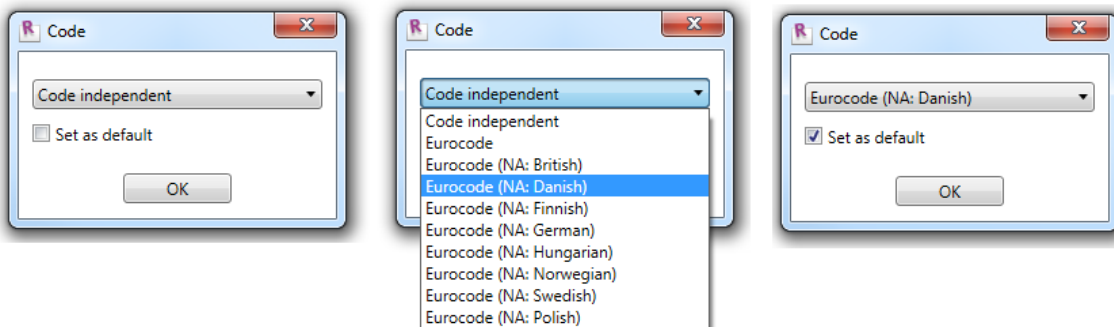

Figure III-32

Upon pressing OK in the *Code* dialog, a *StruXML Export* dialog will appear, as shown in Figure III-33.

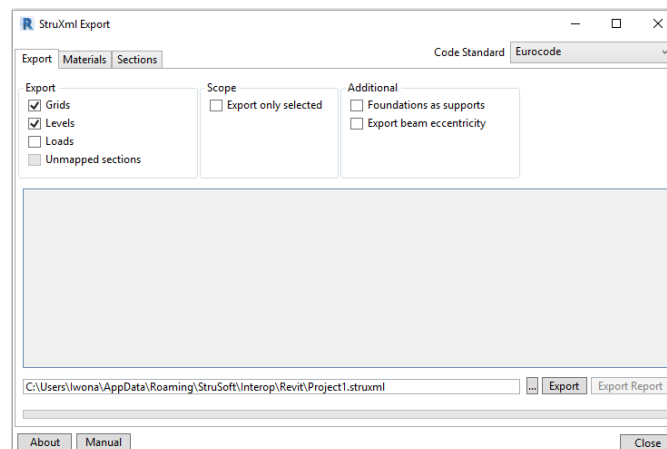

Figure III-33

5.1. Export tab

In the *Export* tab of a *StruXML Export* dialog user can:

- change the previously chosen *Code Standard*,
- decide if to export *Grids*, *Levels* and *Loads*,
- decide if to export *Unmapped sections*,
- decide if to export only selected elements (check *Export only selected*)
- decide if foundation elements should be exported as supports (check *Foundation as Supports*),
- Decide if beams eccentricity should be exported (check *Export beams eccentricity*)
- see the list of warnings (orange bullets) and errors (red bullets), as well as export results listed in the status window,
- export the model to struXML file,
- see the *Export Report* (that becomes active when the export is done).

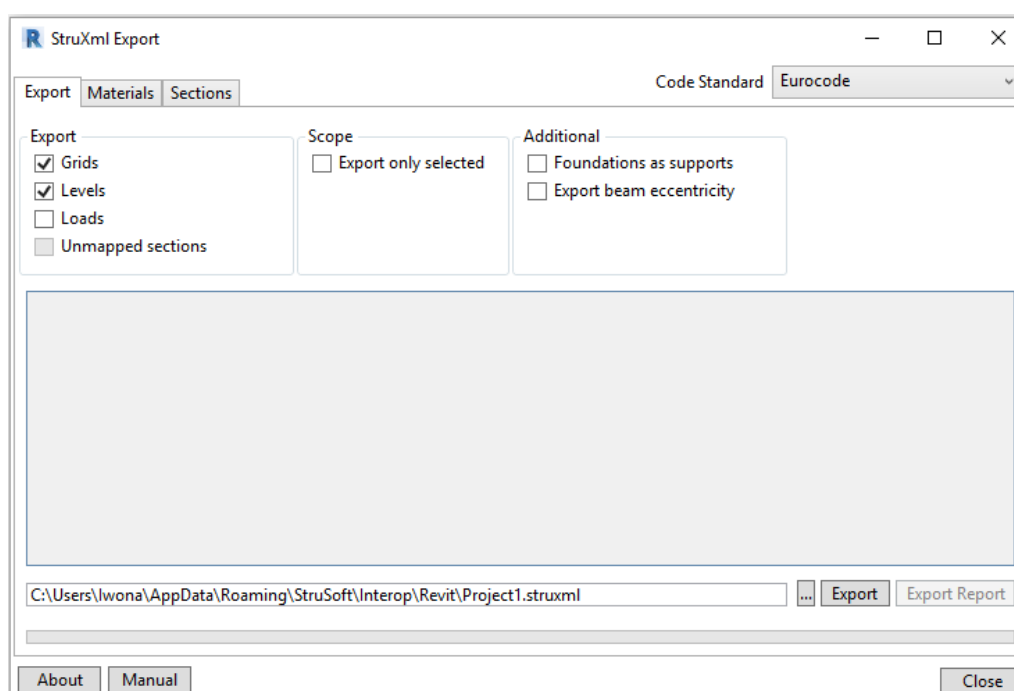

Figure III-34

5.1.1. After launching StruXML Export dialog there are no warnings about unmapped elements, as shown in Figure III-34.

It means that all the materials and profiles used in your current project have already been mapped and saved before, and no mapping is needed. However, it is recommended to go to *Materials* and *Sections* tabs in order to check and approve the previously saved mapping.

In this situation, the procedure is as follow:

1. In the *Export* tab, press an icon with three dots to define location and name of the struxml file.
2. Press the *Export* button to export the model into struxml file.

When the export is finished, an export status will be displayed in the status window as shown in Figure III-35 and the *Export Report* will become active.



Go to Paragraph 0 in order to read about meaning of possible warnings and errors. Go to Paragraph 5.6 in order to read more about the *Export report*.

3. Press *Close* button to close the dialog.

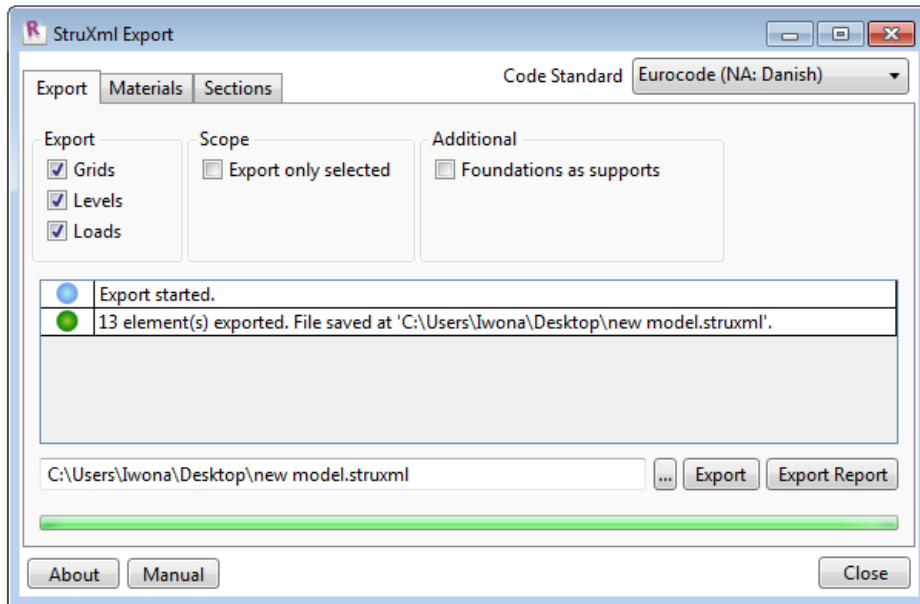

Figure III-35

- 5.1.2. After launching StruXML Export dialog there is a list of warnings about unmapped elements, as shown in Figure III-36.

It means that all or some of the materials and/or sections included in the Revit model have to be mapped to the corresponding materials/sections in FEM-Design.

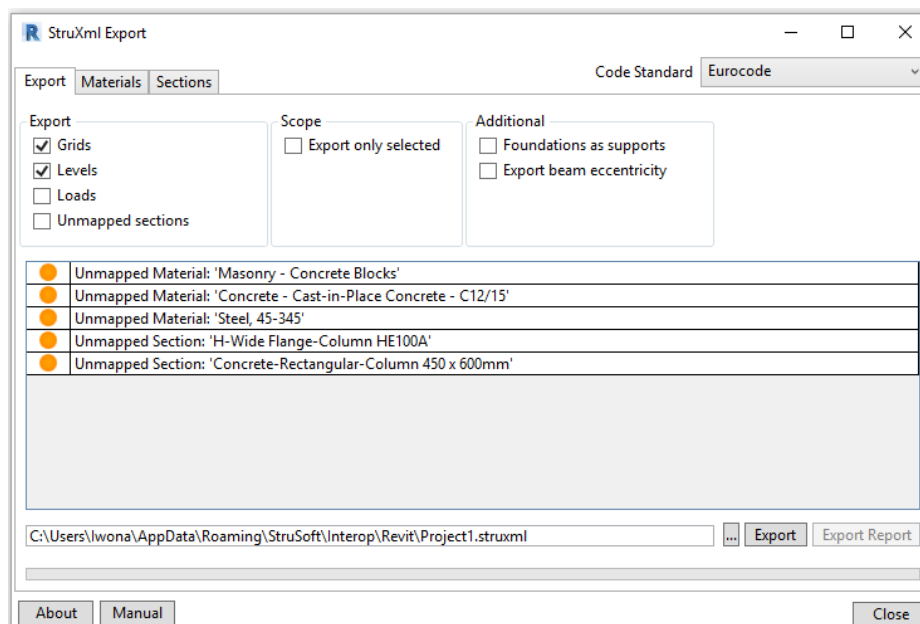

Figure III-36

In this situation, the procedure is as follow:

1. Go to *Materials* tab and map the listed materials (read more about materials mapping in Paragraph 5.2).
2. Go to *Sections* tab and map the listed sections and profiles (read more about sections mapping in Paragraph 5.3) or chose to export unmapped sections.
3. Go back to *Export* tab, and if there is no warning left in the status window, follow the procedure from workflow 1 in order to export the model.

5.2. Materials mapping

In order to map the materials included in the Revit model one should move to *Materials* tab, shown Figure III-37. The dialog is divided into two parts: *Revit* materials in the left part and *FEM-Design* materials in the right part.

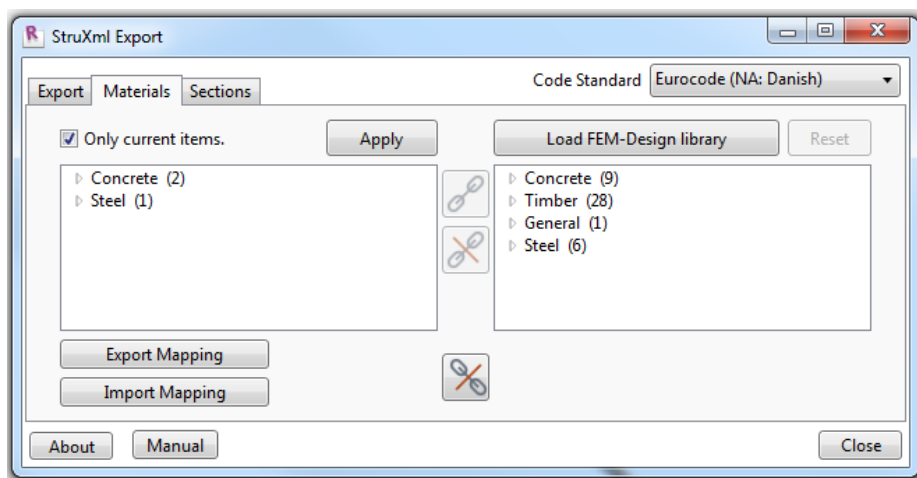

Figure III-37

Only current items

You can decide if you want to see (and map) all the materials from the Revit model library or only those that are currently being used in the model. *Only current items* option is always checked by default. Uncheck it in order to see all the materials from in the Revit library.

In the left window materials, based on their Revit category: *Concrete*, *Metal*, *Wood*, are sorted into following groups: *Concrete*, *Steel*, and *Timber*. Material of any other category than *Concrete*, *Metal*, and *Wood* will be sorted under group *Unassigned*.

Mapping procedure

1. Click on the small triangular next to the material category to open a drop down list of materials to be mapped within this category and select one of the materials. Any material that has to be mapped will be displayed in red. Any of material that have already been mapped before will be displayed in black.
2. Find a corresponding material in the FEM-Design library in the right part of the dialog. Click on the small triangular next to the material category to open a drop down list of available materials from the FEM-Design library and select desired material.
3. Press the *Map selected item* button. Material that has just been mapped turned black.
4. In order to save the material mapping (and update the warning list in the status window in the *Export* tab) press *Apply*.

Unmapping procedure

- If you wish to unmap any of the previously mapped materials, select the material in the Revit materials window and press the *Unmap Selected Item* button.
- If you wish to unmap all of the previously mapped materials, do not select any material – just press the *Unmap All Mapped Items* button.

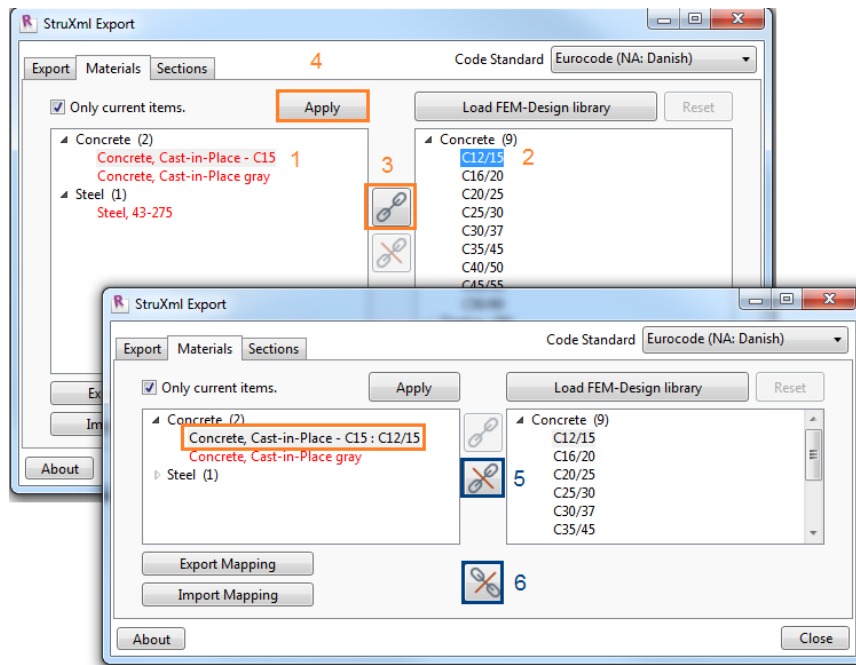

Manual

Figure III-38

Load FEM-Design library

If you added additional materials into FEM-Design materials library and you wish to perform mapping into those materials, you need to update the default FEM-Design library in the *StruXML Export* dialog to the desired one. The code of the new materials library imported from FEM-Design has to be consistent with the chosen *Code Standard* in the *StruXML Export* dialog.

The procedure is as follows (shown in Figure III-39 and Figure III-40):

1. In FEM-Design go to the *Default settings* of e.g. *Colum*.
2. Go to *Material* tab.
3. Press the *Export...* button.
4. Chose *Material library (*.struxml)* in Save as type, find a location and name the library.
5. Chose *Save* button.
6. Go back to the *Materials* tab in the *StruXML Export* dialog and press *Load FEM-Design library*. Find and select the desired struXML file.
7. Press *Open* button.



Remember to always load the current FEM-Design library. This will prevent from mapping into a material that may not exist in the current library used in FEM-Design.

Press *Reset* button in order to reset the materials library to the default one.

Export / Import Mapping

Once performed materials mapping can be saved to struXML file using *Export Mapping* button. Use *Import Mapping* button in order to load mapping from struXML file.

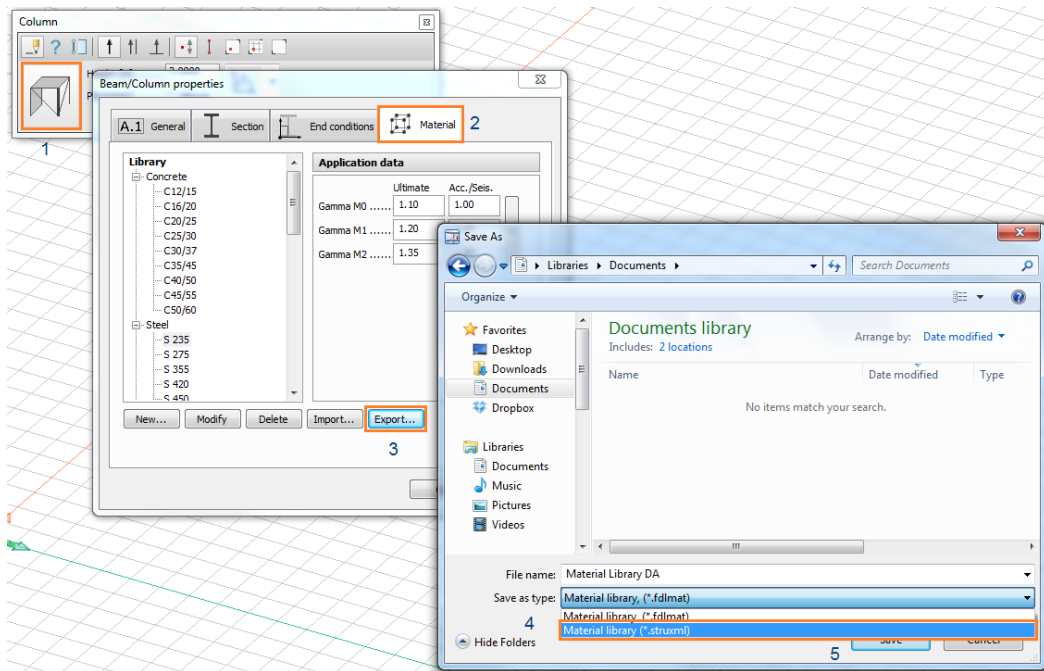

Figure III-39

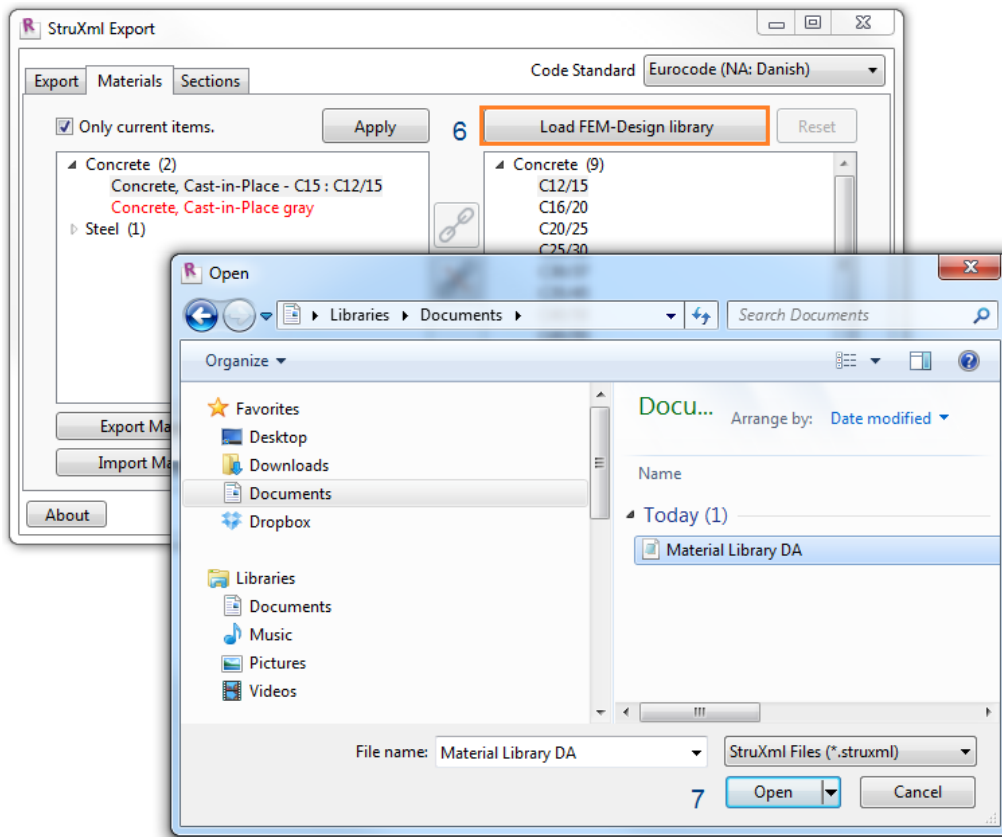

Figure III-40

5.3. Sections mapping

In order to map the sections one should move to *Sections* tab shown in Figure III-41. The dialog is divided into two parts: *Revit* sections in the left part and *FEM-Design* sections in the right part.

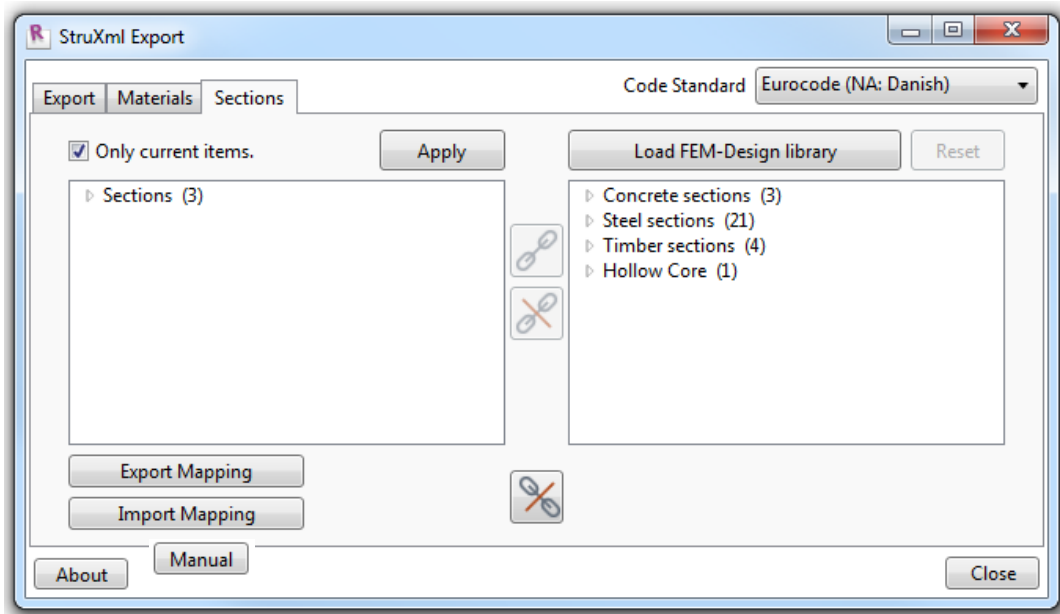

Figure III-41

Only current items

At a start you can decide if you want to see (and map) all the sections from the Revit model library or only those that are currently being used in the model. *Only current items* option is always checked by default. Uncheck it in order to see all the sections and profiles from in the Revit library.

In the left window Revit sections are listed without being grouped to any category.

Mapping procedure

1. Click on the small triangular next to the *Sections* to open a drop down list of sections to be mapped and select one item. Any section that has to be mapped will be displayed in red. Any of section that have already been mapped before will be displayed in black.
2. Find a corresponding section in the FEM-Design library in the right part of the dialog. Click on the small triangular next to the section category to open a drop down list of available sections from the FEM-Design library and select a desired one.
3. Press *Map selected item* button. A section that has just been mapped will turn black.
4. In order to save the sections mapping (and update the warning list in the status window in the *Export* tab) press *Apply*.

Unmapping procedure

- If you wish to unmap any of the previously mapped sections, select the section in the Revit sections window and press the *Unmap Selected Item* button.
- If you wish to unmap all of the previously mapped sections, do not select any section – just press the *Unmap All Mapped Items* button.

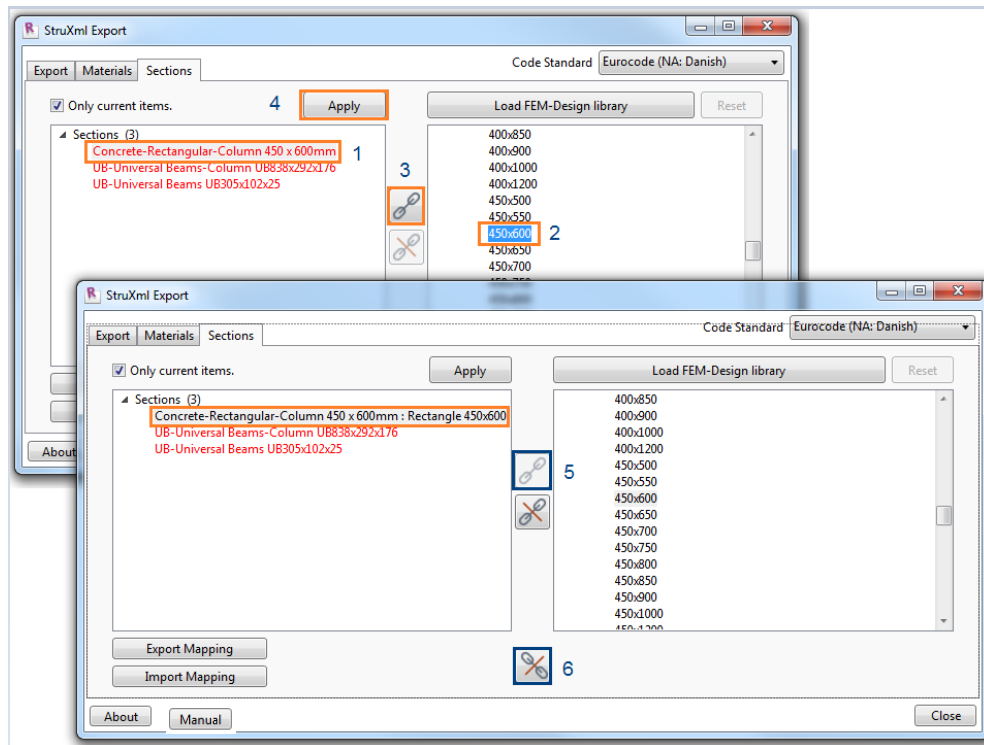

Figure III-42

Load FEM-Design library

If you added additional sections into FEM-Design sections library and you wish to perform mapping into those sections, you need to update the default FEM-Design library to the desired one. The code of the new sections library imported from FEM-Design has to be consistent with the chosen *Code Standard* in the *StruXML Export* dialog.

The procedure is as follows:

1. In FEM-Design go to the *Default settings* of e.g. *Column*.
2. Go to *Sections* tab.
3. Press the *Export...* button.
4. Chose *Sections library (*.struxml)* in *Save as type*, find a location and name the library.
5. Chose *Save* button.
6. Go back to the *Sections* tab in the *StruXML Export* dialog and press *Load FEM-Design library*. Find and select the desired struXML file.
7. Press *Open* button.



Remember to always load the current FEM-Design library. This will prevent from mapping to a section that may not exist in the current library used in FEM-Design.

Press *Reset* button in order to reset the materials library to the default one.

Export / Import Mapping

Once performed sections mapping can be saved to struXML file using *Export Mapping* button. Use *Import Mapping* button in order to load mapping from struXML file.

5.4. Export unmapped sections

A new option has been introduced in the StruXML Export that allows for exporting unmapped section.

In previous versions of the StruXml StruSoft Add-In, both all the materials and sections had to be mapped to corresponding objects from FEM-Design library, otherwise elements with unmapped material or section were not exported.

From now on, it is possible not to map the sections (the materials still have to be mapped) and let the StruXML StruSoft Add-In create them automatically in FEM-Design.

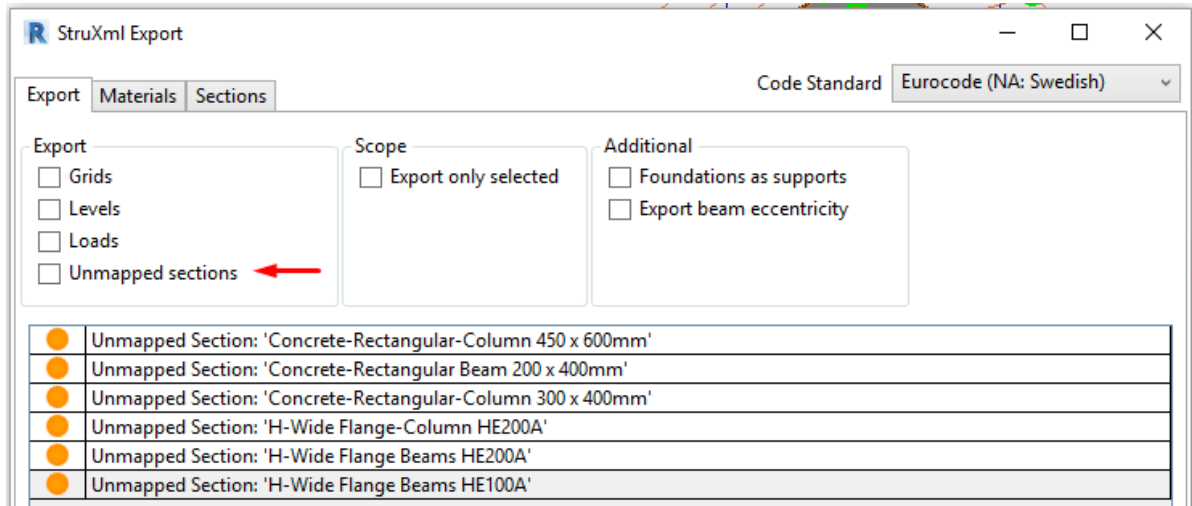

It is possible not to map any section, or map only some sections, and let the Add-In create the rest, as shown in the example below.

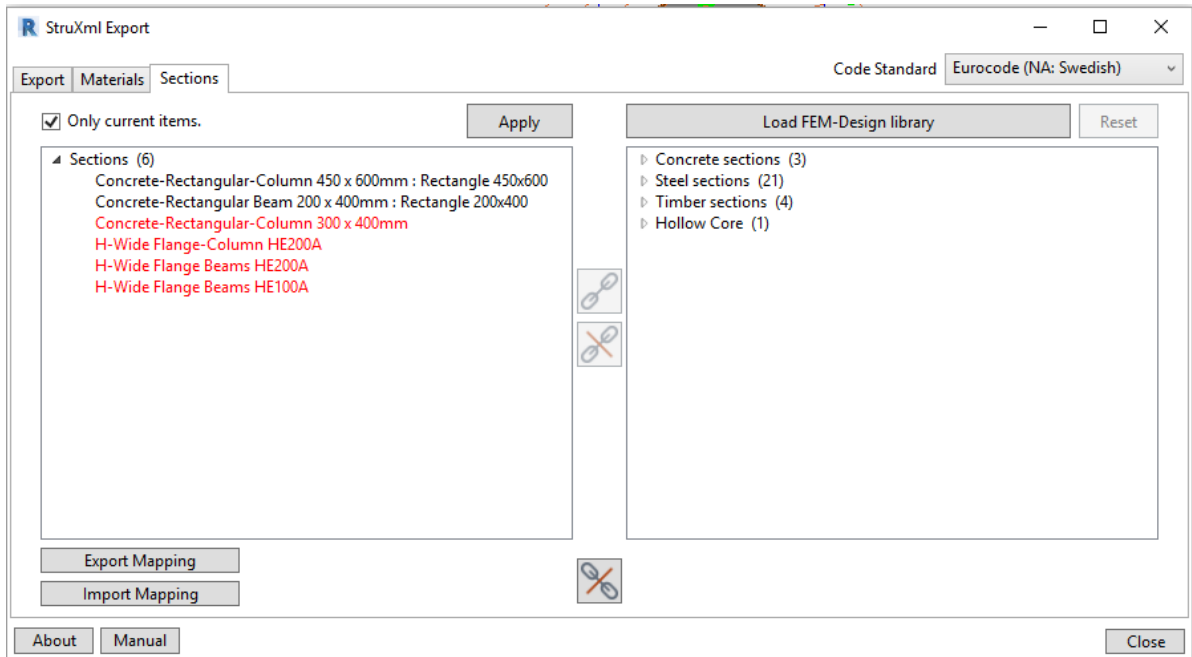

In the Export tab, simply chose to Export unmapped sections (when this option is chosen, the list of warnings about unmapped sections will disappear).

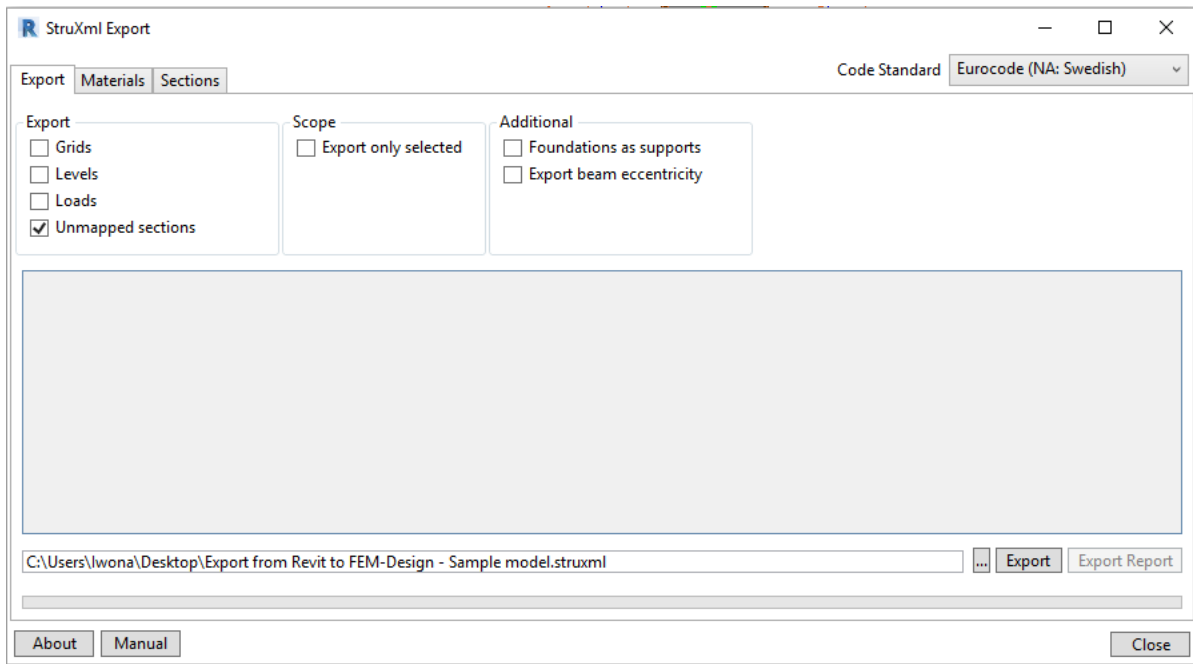

In FEM-Design, the unmapped Revit sections are listed under Used sections, and are named as the sections in Revit.

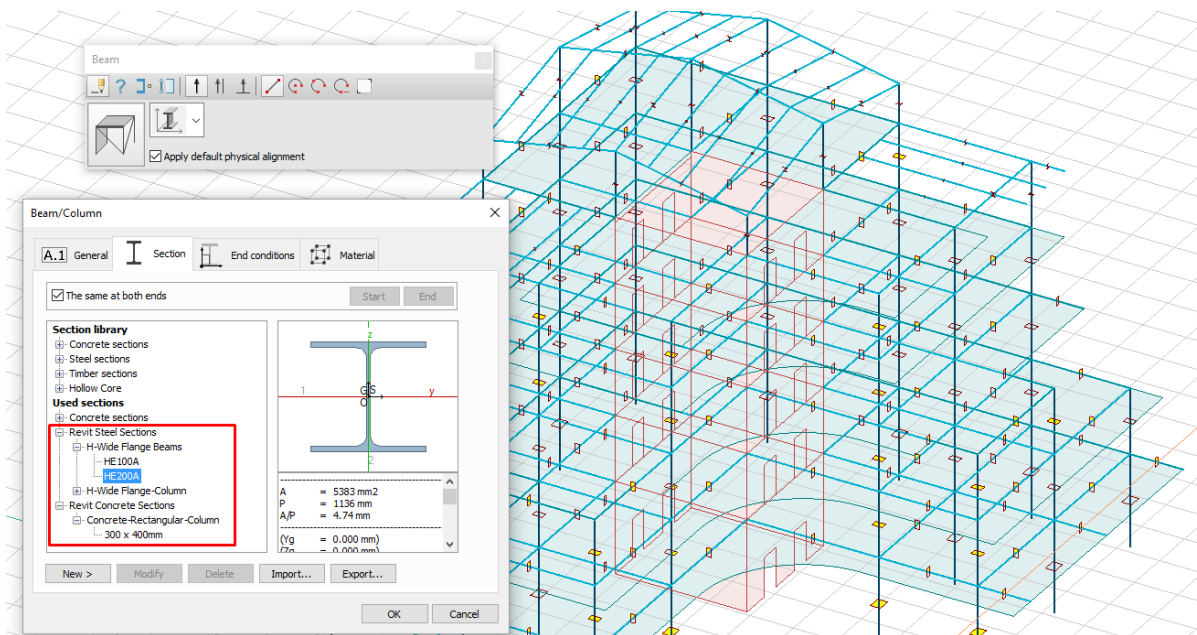

Keep in mind that if you choose to export unmapped sections, new sections will be created in FEM-Design, even though similar sections exist in FEM-Design library. If you want your Revit object to have the original FEM-Design sections, use the regular mapping procedure.

In case of an attempt of export unmapped sections that do not have a constant section (examples shown below) the Add-In will send a warning that such section cannot be exported (since it cannot originally exist in FEM-Design).

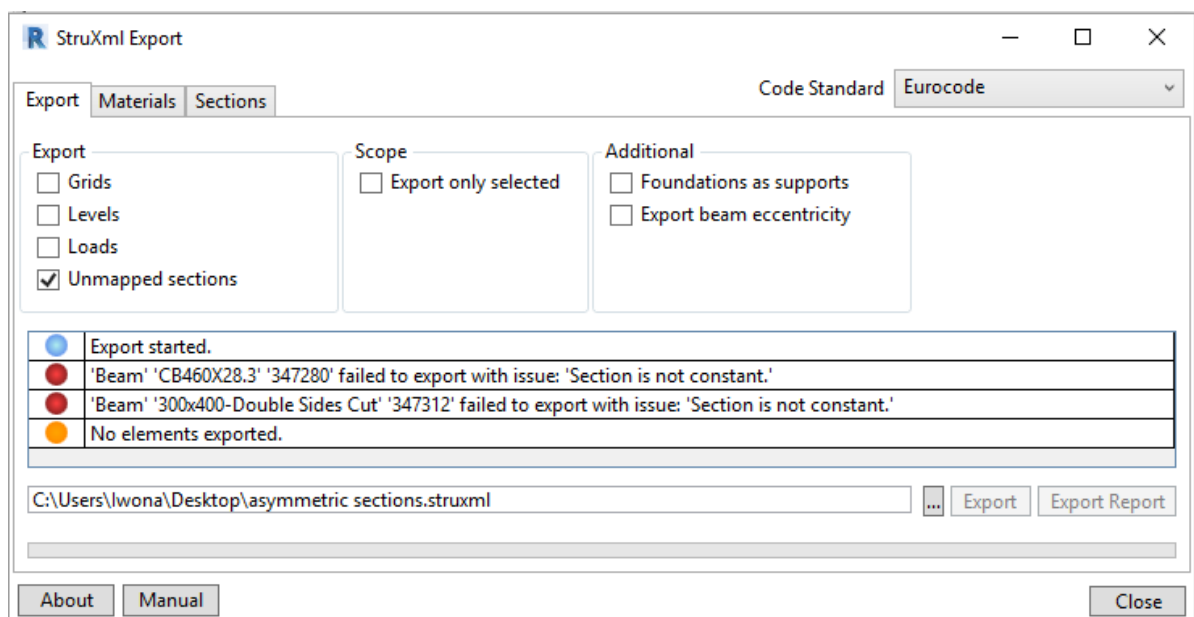
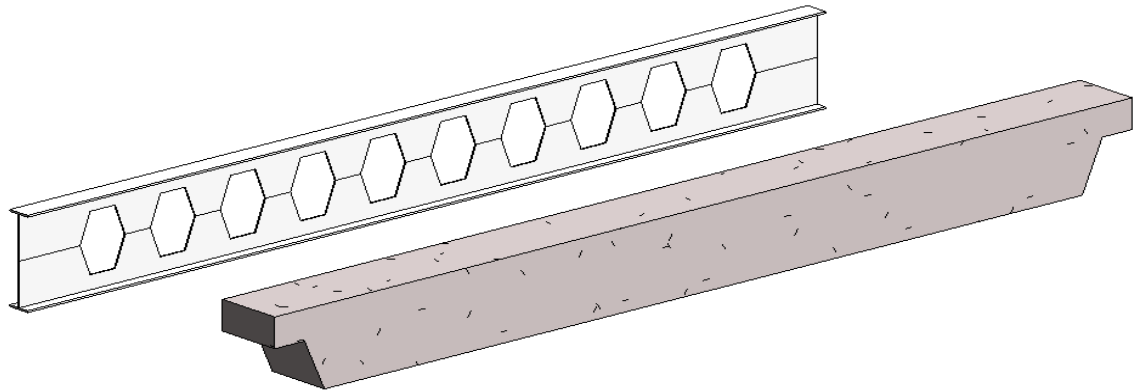

5.5. Warnings and errors

Here is a list of all possible warning and error messages that can appear while using the Revit to FEM-Design StruXML Add-In:

Warning: Unmapped Material: "Name of the material from Revit"

Explanation: This warning may appear in the status window after launching StruXML Export dialog. It only warns that there are some materials in the Revit model that have not been mapped yet. The warning will disappear after the material is mapped and the material mapping is confirmed with the Apply button.

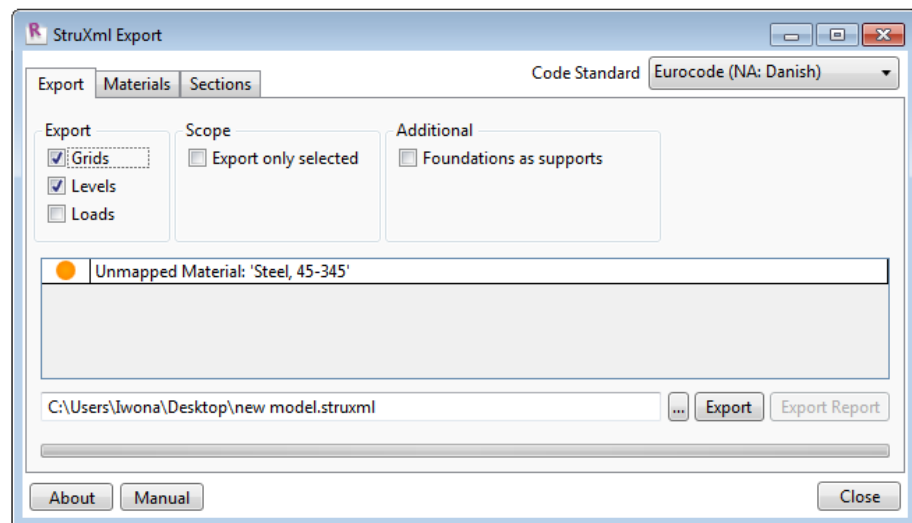

Figure III-43

Warning: Unmapped Section: "Name of the section from Revit"

Explanation: This warning may appear in the status window after launching StruXML Export dialog. It only warns that there are some sections in the Revit model that have not been mapped yet. The warning will disappear after the sections are mapped and the sections mapping is confirmed with the Apply button.

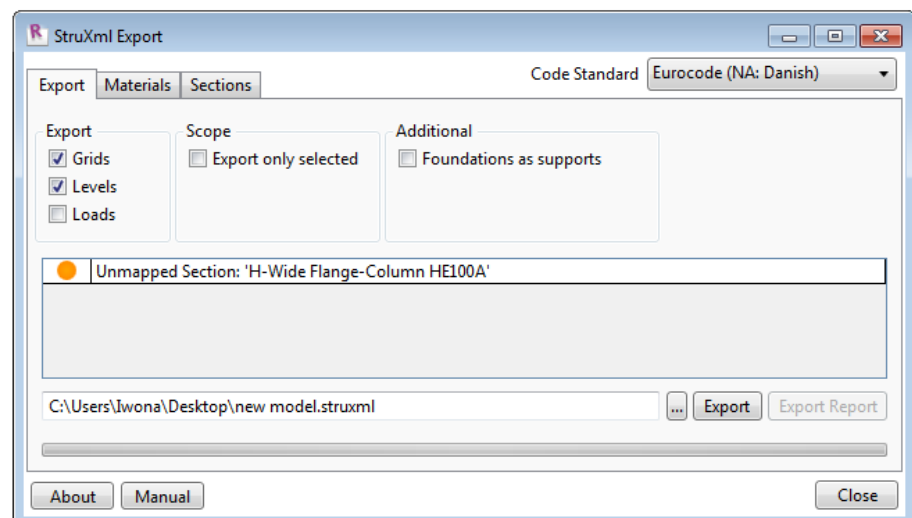

Figure III-44

Warning: Element: "Type" "Number" can't export eccentricity.

Explanation: This warning may appear in the status window after exporting a beam section for which eccentricity settings could not be exported. The eccentricity configuration that cannot be exported to struxml is when the start and end part of the analytical beam are not the same. Read more in Chapter 4.7.

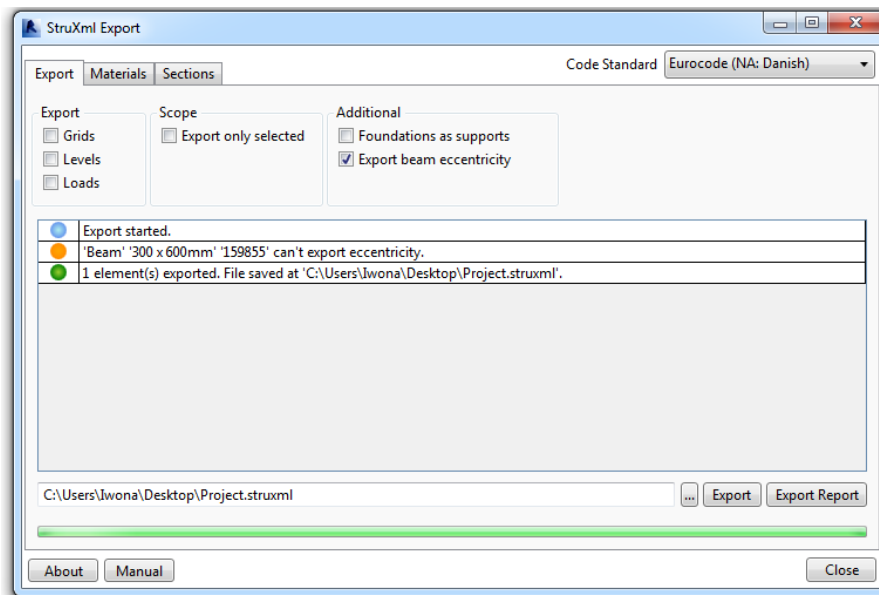

Figure III-45

Warning: Element: "Type" "Number" column is slanted.

Explanation: This warning may appear in the status window after exporting a column that is slanted. This is to warn the user in case a slanted column was just a modeling mistake.

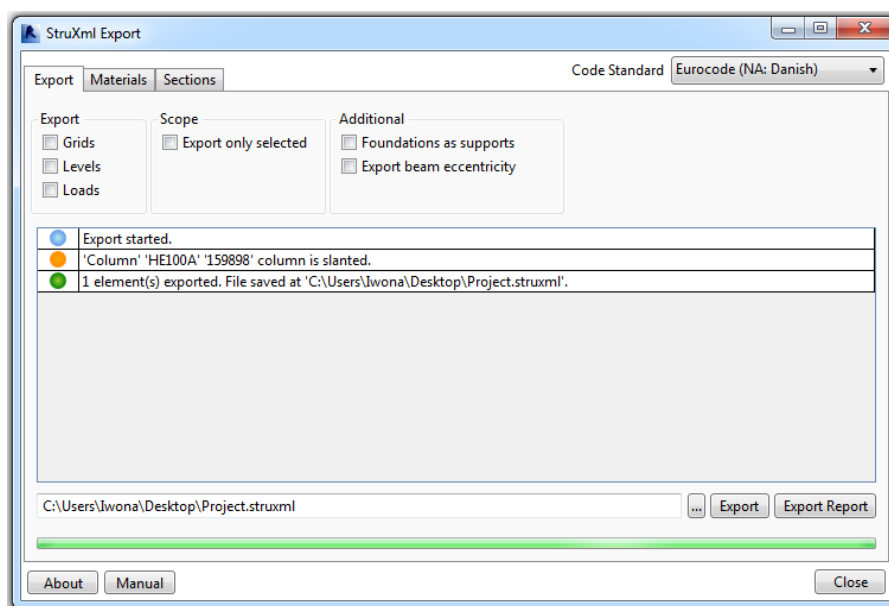

Figure III-46

Error: The code standard of the file and application differ.

Explanation: This error will appear if you try to *Load FEM-Design library* that has a different *Code Standard* than the chosen *Code Standard* in the *StruXML Export*. Both the code standards have to be consistent in order to perform a valid mapping.

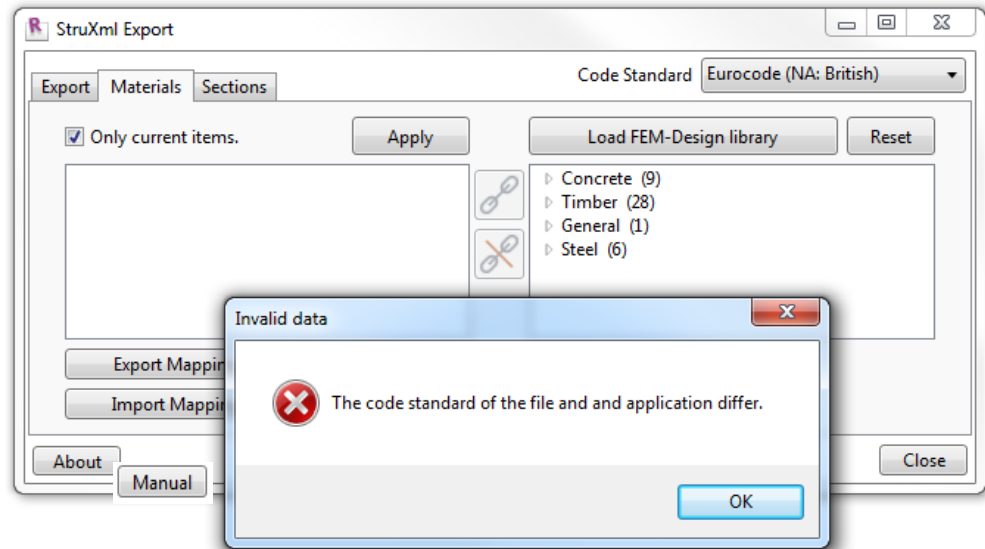

Figure III-47

Error: There are no structural elements in the document, therefore levels cannot be exported.

Explanation: This error will appear if you try to *Export Levels* but there are no elements in the Revit model. This is not possible as the size of the *Storey* in FEM-Design cannot be then calculated if there are no elements in the Revit model.

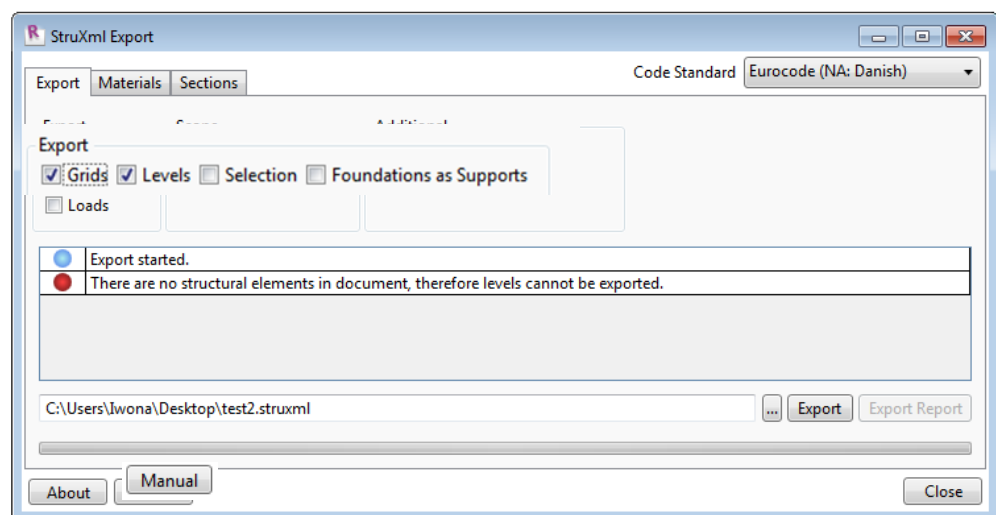

Figure III-48

Error: "Element type" "Type" "Number" failed to export with issue: 'Lack of analytical model'

Explanation: This error will appear after an attempt to export a Revit model that includes an element that do not have analytical model enabled. Elements with no analytical model cannot be exported to FEM-Design. This will warn you about it and give you a chance to correct your model and repeat the export.



In case there are some elements that should not be exported to FEM-Design and therefore, they do not have analytical model enabled (e.g. partition walls), this error can then be ignored.

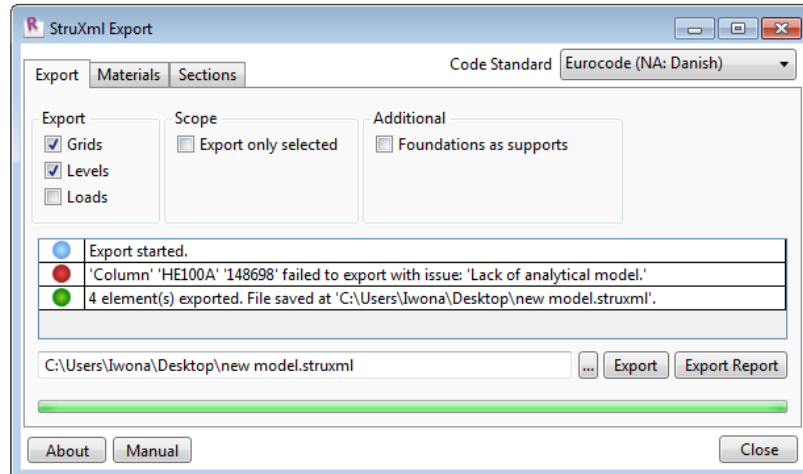

Figure III-49

Error: “Element type” “Type” ”Number“ failed to export with issue: ‘No structural material assigned to it’

Explanation: This error will appear after an attempt to export a Revit model that includes an element that do not have a structural material assigned to it. If a structural material is set to be <By Category> it cannot be exported to FEM-Design. This will warn you about it and give you a chance to correct your model and repeat the export.



This kind of error may appear only for elements that have analytical model enabled. In case there are elements in your Revit model that are not meant to be exported and therefore, do not have analytical model and structural material assigned, you will first receive information about lack of analytical model in those elements.

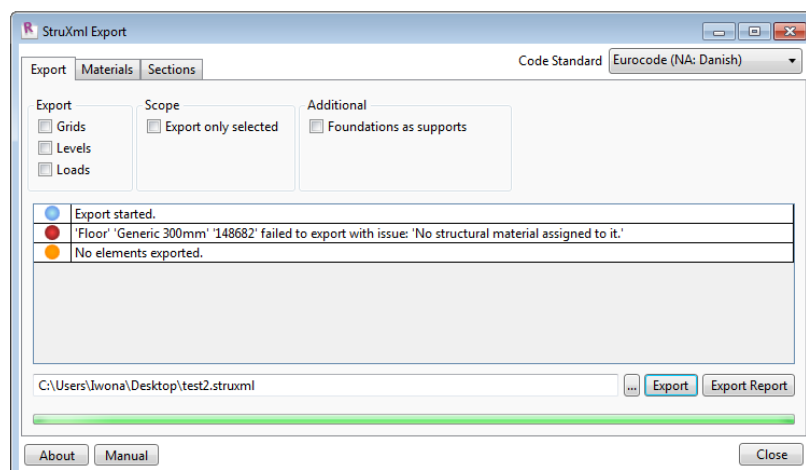

Figure III-50

Error: Element: “Type” ”Number“ failed to export with issue: ‘Material has not been mapped’

Explanation: This error will appear if the warning about unmapped material has been ignored and

the export was performed anyway. Element without mapped material cannot be exported to FEM-Design.

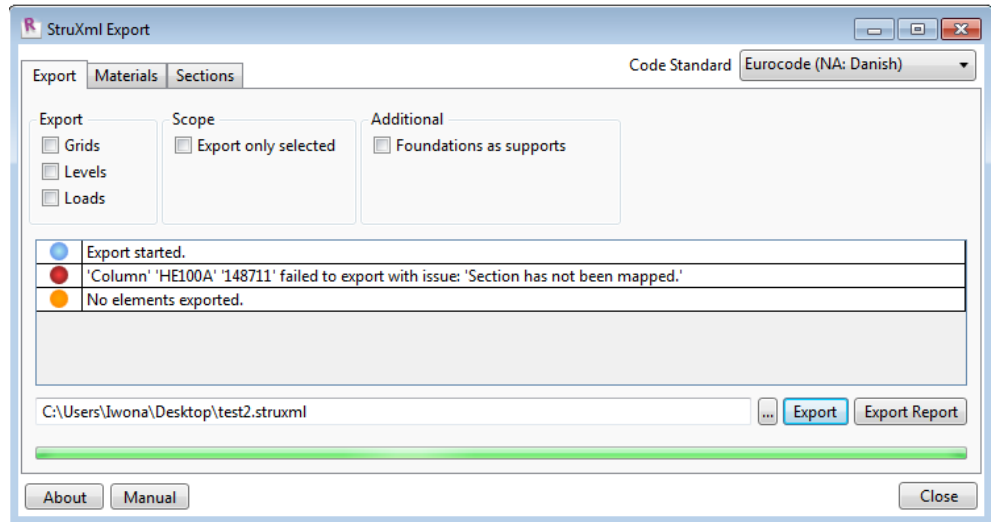

Figure III-51

Error: Element: "Type" "Number" failed to export with issue: 'Section has not been mapped'

Explanation: This error will appear if the warning about unmapped section has been ignored and the export was performed anyway. Element without mapped material cannot be exported to FEM-Design.

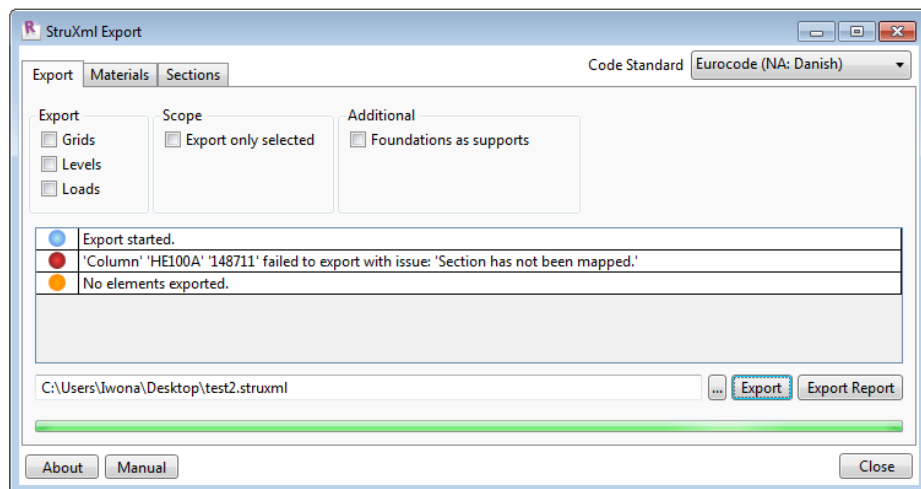

Figure III-52



Double click on the warning message in order to zoom into the element with an error.

5.6. Export report

After a Revit model is exported to struxml, an *Export Report* button will become active in the *StruXml Export* dialog.

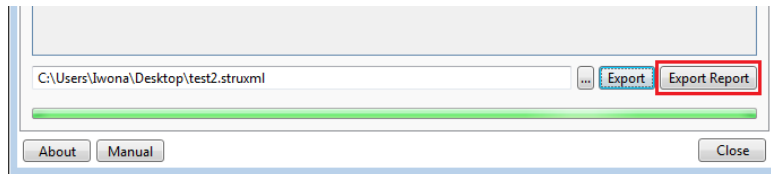

Figure III-53

Upon pressing the *Export Report* button, the Extended Report dialog will appear. Report is based on listing of elements in three groups. User can decide according to which criterion the elements should be listed in each of the groups.

One can chose between:

- *Exported*: elements are grouped based on the fact if they were successfully exported or not.
- *Name*: elements are grouped by the elements group name, e.g. Beam, Column, Grid line, etc.
- *Type*: elements are grouped by the type of the family instance.
- *ID*: elements are grouped by the ID number.
- *Message*: elements are grouped by the type of the message / warning message.

Upon clicking in the small triangular symbol next to each group of elements listed in the report, this group can be minimized. Three different examples are presented below:

Exported → Name → Type.

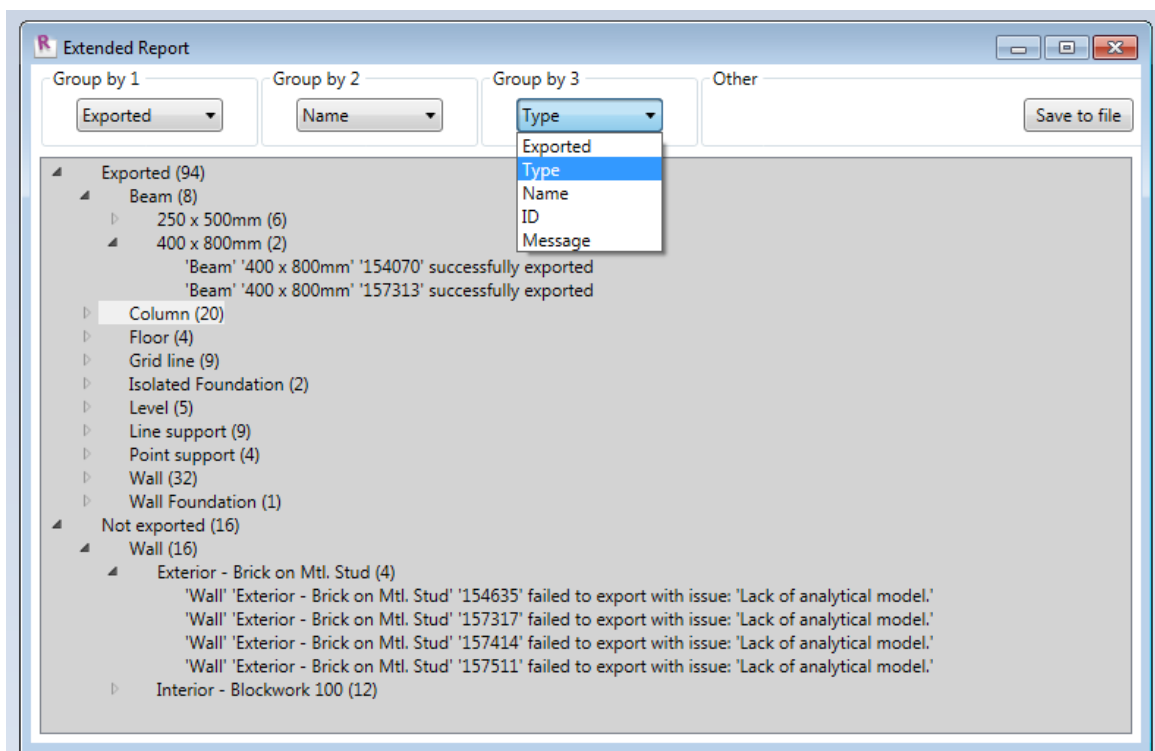

Figure III-54

Figure III-54 shows an example of how the report can be arranged. In the first group, elements are grouped by *Exported* into exported (94 elements) and not exported elements (16). Then elements are grouped by *Name*. There are 8 beams exports, 20 columns, 4 floors, 9 grid lines, etc. There are also 16 walls that were not exported. Finally, the elements are grouped by *Type*.

We can see that out of 8 beams that were exported, 6 of them were of a type 250 x 500mm and 2 of them 400 x 800mm, etc. We can also see that there were two types of walls that were not exported and the reason for that was the lack of analytical model.

Name → Exported → Type.

Figure III-55 shows another suggested way of arranging the report (of the same model as in the previous case).

Elements in a first place are grouped by name. Afterward, they are split into elements of this group that were exported and those that were not. In the last step, they are divided into types. For instance, we can see there were 48 walls, out of which 32 were exported and 16 were not exported due to lack of analytical model. We can also see how many walls of which type were and were not exported.

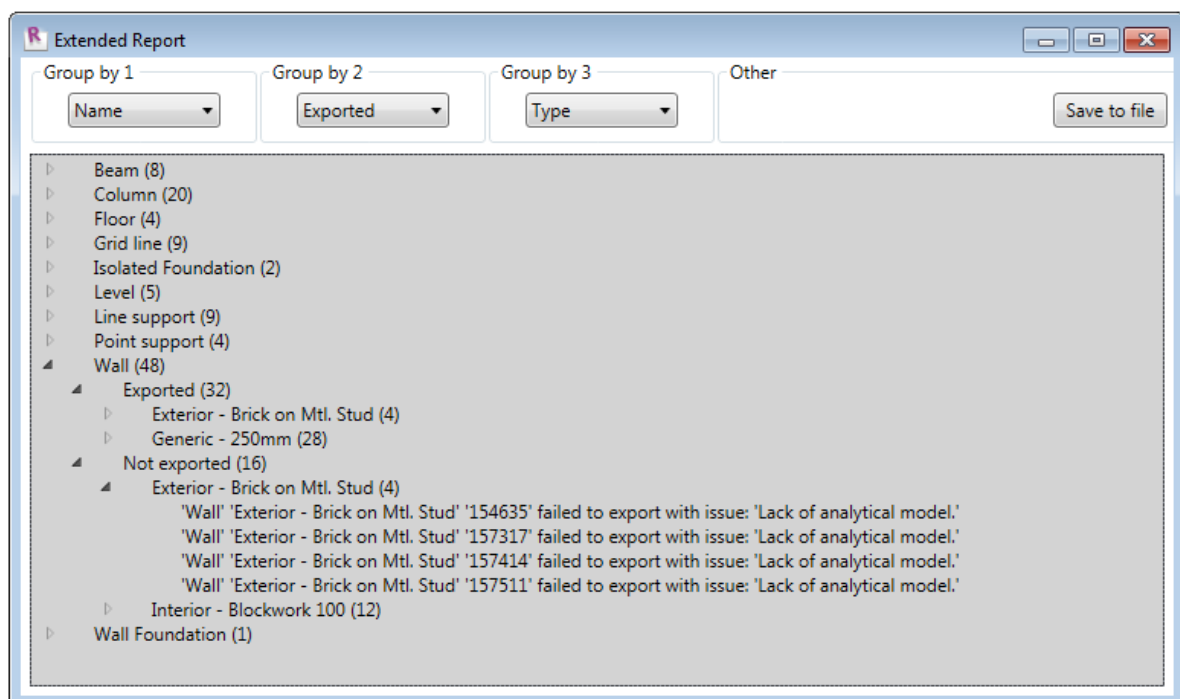

Figure III-55

Name → Type → Exported

The last example shows how to arrange elements if you want to see how many elements of a given type were exported and how many were not.

In the Figure III-56, we can see that there were 8 walls of a given type, 4 of them were exported and 4 of them failed due to lack of analytical model.

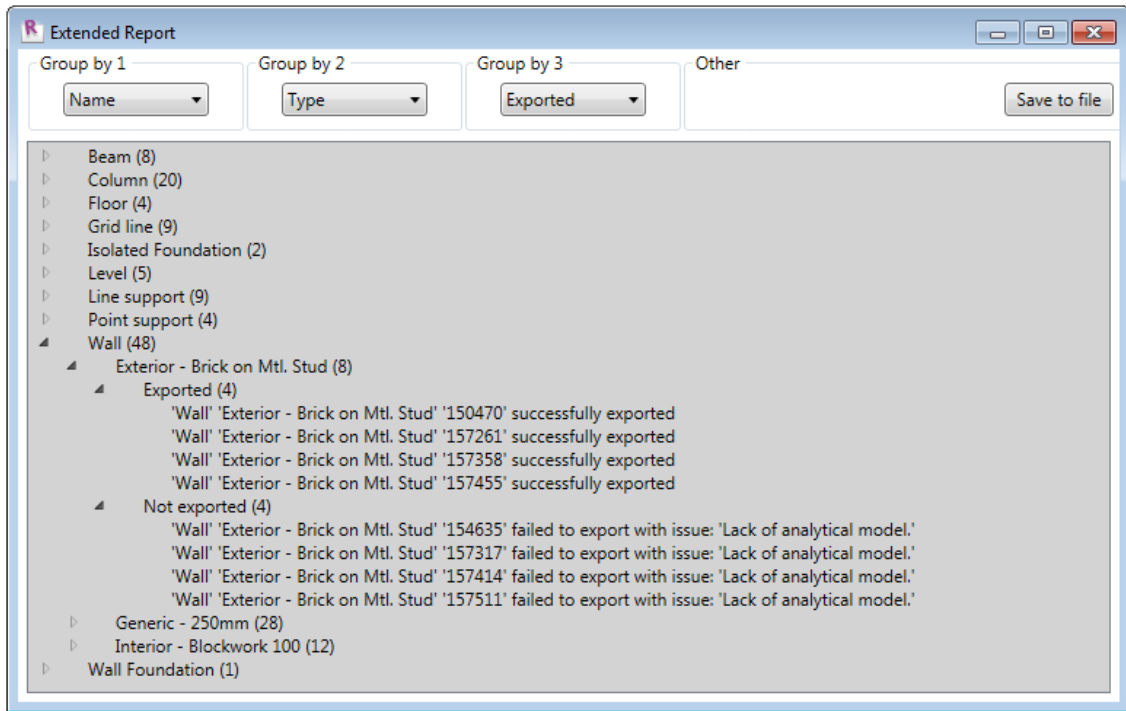

Figure III-56

Save the report

Upon pressing the *Save to file* button, one can save the generated report into txt file. The .txt file can be nicely open in WordPad / Word or any Internet browser. We do not recommend opening it in Notepad, as the structure of the report is not preserved.

In order to open the .txt file in other instance than Notepad, right click on the file and chose Open with. Then select the desired program (WordPad, Word, Internet browser, etc.). Be aware that when you export the report into a file, all the groups will be maximized displaying all elements listed below each group. However, you can easily modify the report in the text editor and remove the unnecessary lines before printing the report.

Figure III-57 shows how the exported report can look like, when opened in the Internet browser.

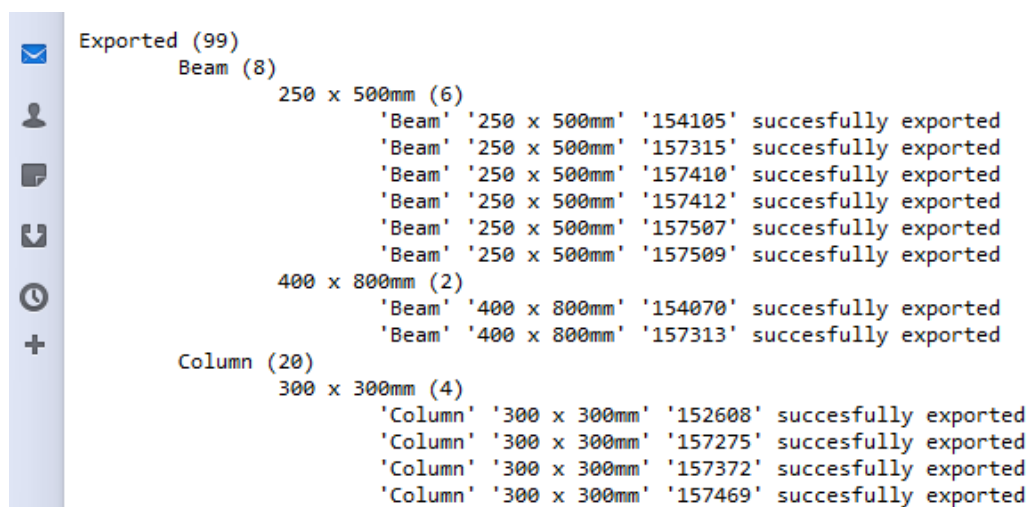

Figure III-57

5.7. Open StruXML

StruXML file containing exported model from Revit has to be open directly in FEM-Design. StruXML files can only be open in the *3D Structure* module of *FEM-Design 11* (starting from version 11.01.001) and higher versions.

Procedure is as follows:

1. Open *FEM-Design 3D Structure*.
2. From the main menu choose: *File* → *Open*.
3. Choose *StruSoft common structure XML files (*.struxml)* in the *Files of type* and browse for the desired file.
4. Press *Open* button.

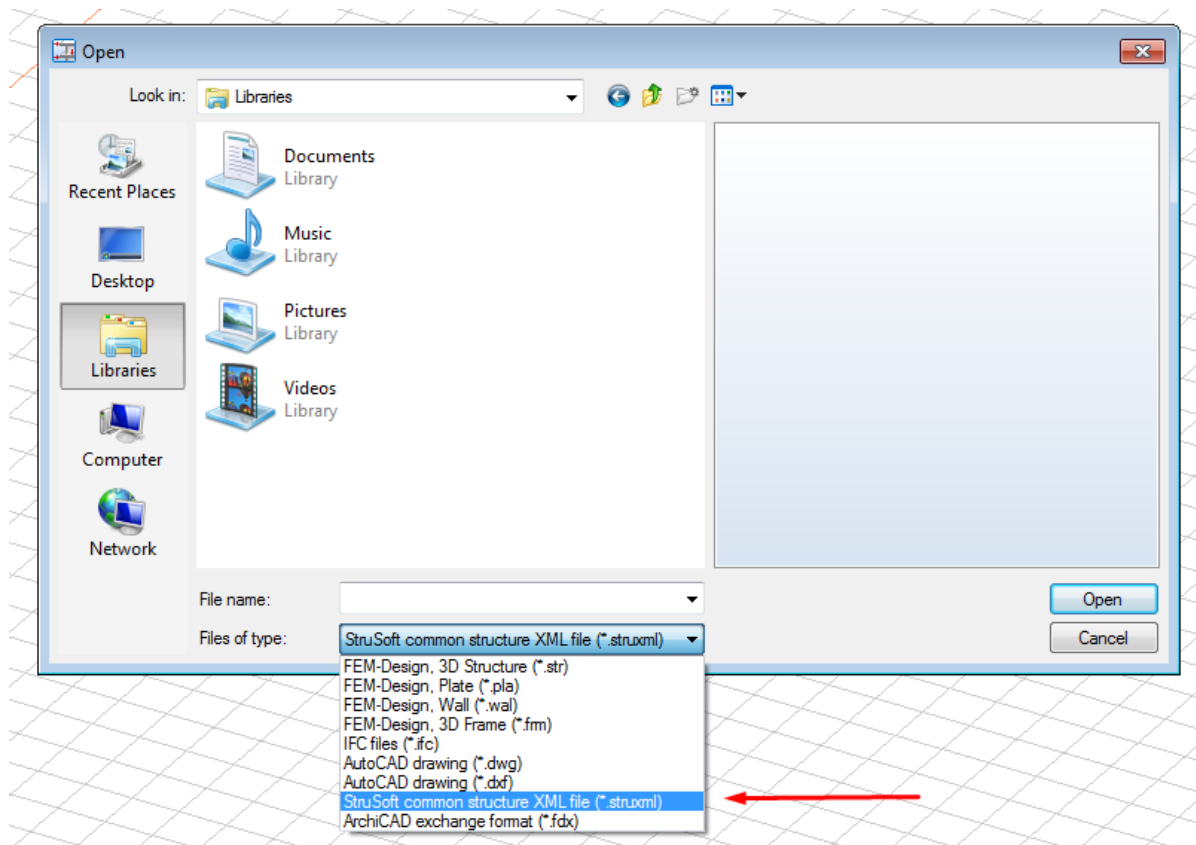

Figure III-58

6. Limitation and recognized issues

Structural material given to adjacent object

If a single linear object (beam, columns) does not have a valid structural material (is set to <By Category>), it cannot be exported due to lack of material. Also the Structural material search tool will recognize it as object without a valid material.

But, in some situations when this linear object is connected (in a certain way) to another object e.g. floor that has a valid structural material, Revit will by default apply this material to our linear object. This is however, not clear from the user interface – our object's material will still be set to <By

Category>. In such case, the linear object will not be recognized as one without a material and will be exported with the material given by the adjacent object.

It is not known to us what the exact situations are and when the adjacent object's material will be given by Revit to a connected object without a material.

Eccentricity issues in export of (some) mono-symmetric profiles

Some of mono-symmetric sections families in Revit (examples shown below) often have a reference line defined in the middle of section height, which is not a center of gravity of that section.

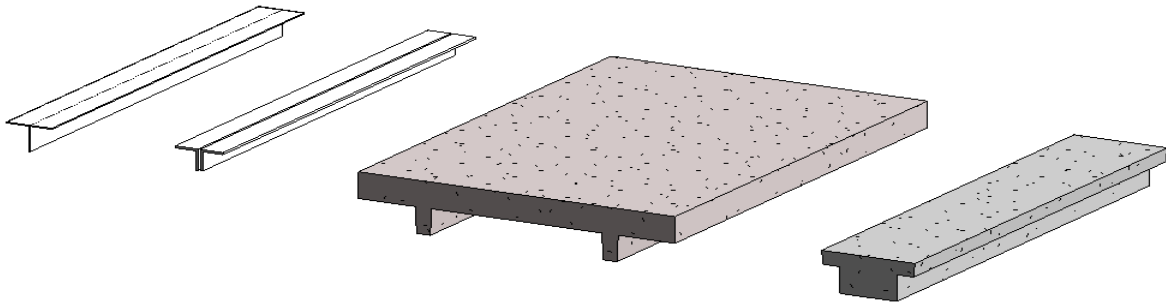

When such section is exported to FEM-Design with the option to export beams eccentricity, the center of the gravity is applied correctly, but the eccentricity settings (how a physical section is located in relation to the beam's analytical model) is not read correctly due to the difference between Revit and FEM-Design's approach.

Example of such is shown in figure below. The physical eccentricity should be set to top, but instead is placed outside it the section.

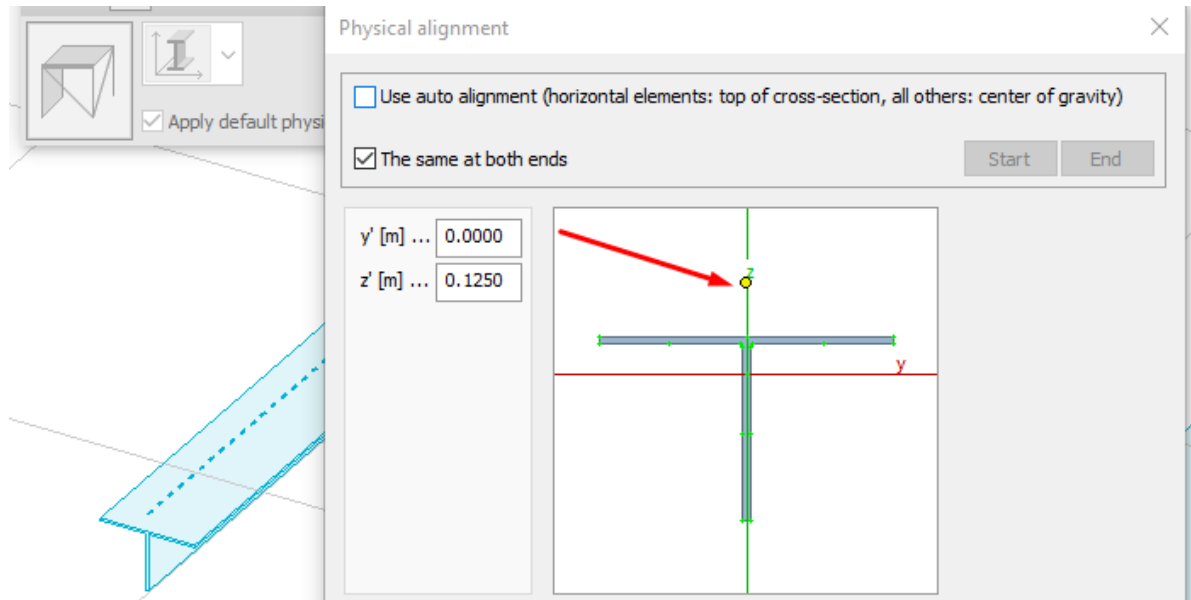

The solution is to:

- adjust the physical eccentricity manually in FEM-Design,
- or do not export beam's eccentricity - in such case the physical eccentricity in FEM-Design will be applied to center of gravity of a section). This is the default option in export settings.

Mirrored section issue in export of asymmetric and (some) mono-symmetric profiles

Example of asymmetric and mono-symmetric profiles in Revit:

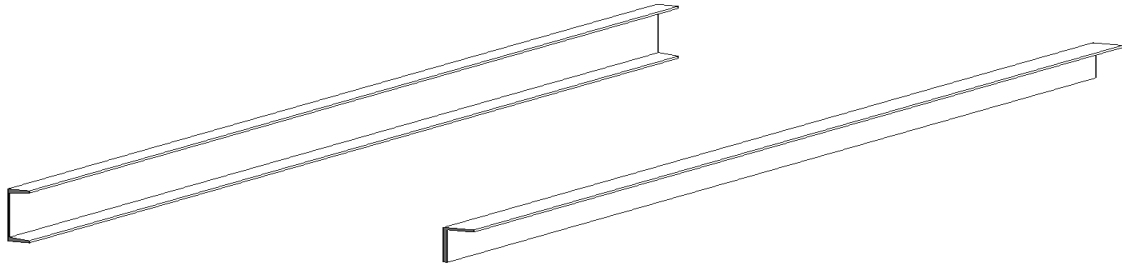

This is how these sections will look like after importing them to FEM-Design: the sections are mirrored.

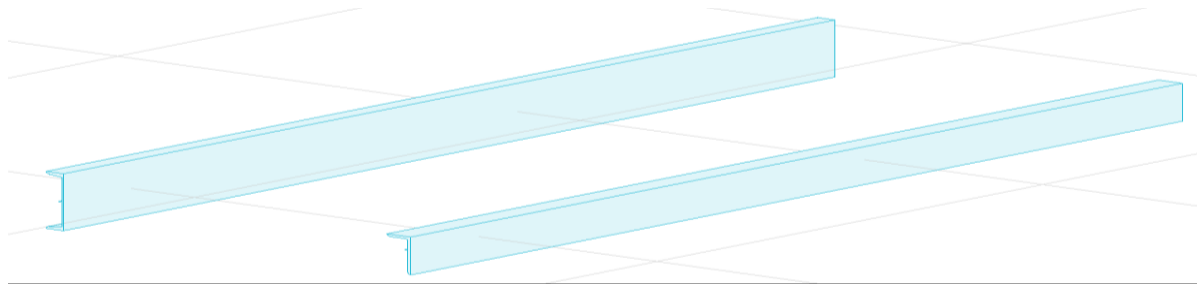

Rotation problem in export of asymmetric and (some) mono-symmetric column profiles

Example of different column profiles in Revit and the result of exporting unmapped sections to FEM-Design. As visible, the asymmetric and mono-symmetric profiles are not exported with the correct rotation.

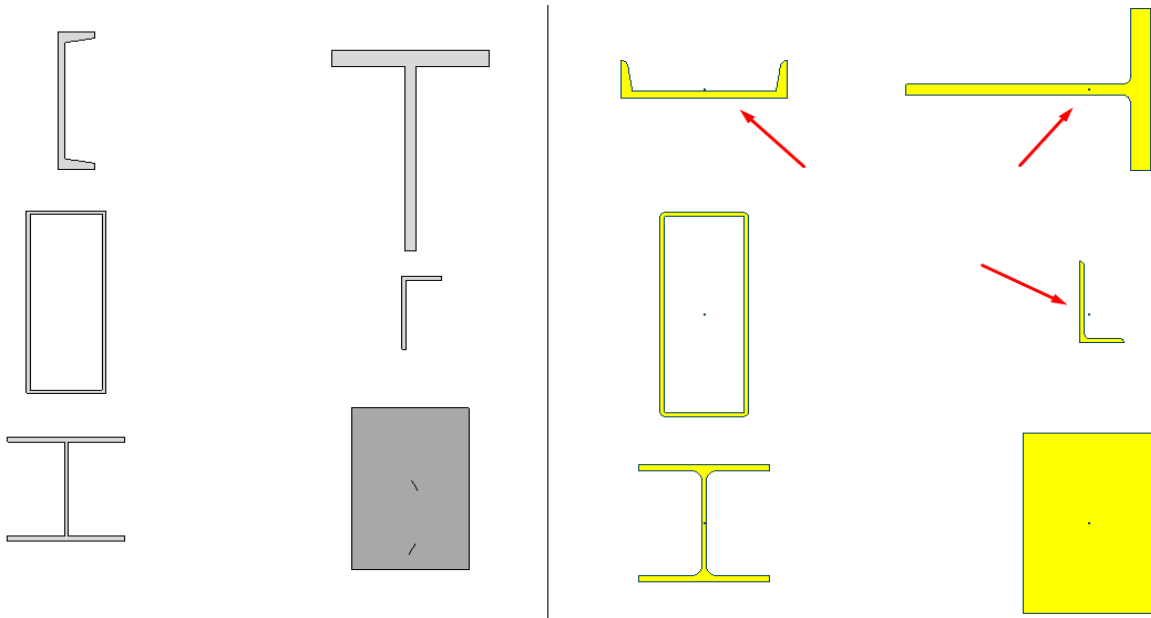

At the moment we are not able to solve any of the issue, but we will do our best to provide some solution in one of the coming Add-In releases.

IV. Workflow: FEM-Design to Revit

The new workflow, import a FEM-Design model into Revit, has been introduced in StruSoft StruXML Revit Add-In 1.1.001.



It is not recommended to import FEM-Design models created in version earlier than 13 into struxml. It cannot be guaranteed that all files created in older version will be properly recognized in Revit and in many cases an *Invalid file* warning may appear when trying to import such file.

7. Data exchange scope

Following elements can be imported from FEM-Design to Revit using the StruSoft StruXML Revit Add-In:

Elements:

- Datum elements (axes and storeys)
- Bar elements (beams, columns, trusses)
- Shell elements (walls and plates)
- Profiled plate panels (imported as plates)
- Foundation elements (isolated foundations, wall foundations, foundation slabs)
- Supports
- Loads and load cases

Detailed description on how particular elements are imported, and which properties can be transferred along with the element, are presented in the following chapters.

7.1. Datum elements

Datum elements in FEM-Design, i.e. *storeys* and *axes* can be saved into struxml file and imported to Revit project.

7.1.1. Storeys

Definition of *Storeys* is imported to Revit project as *levels* however, the *default* Storey name from FEM-Design is not imported; the imported levels will be called Level 1, Level 2, etc. as shown in the example in Figure IV-1.

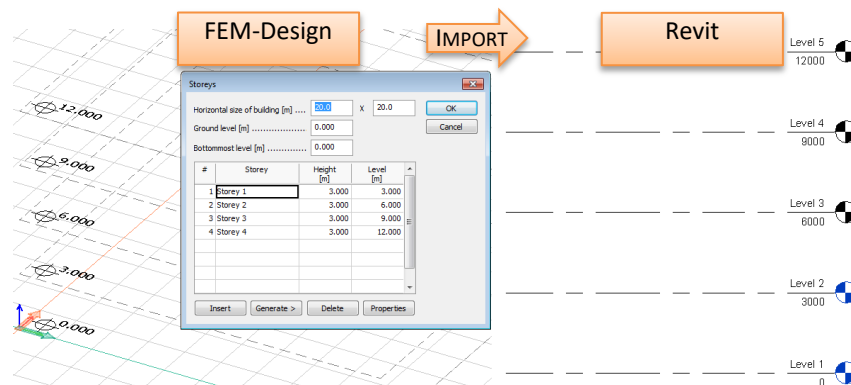

Figure IV-1

7.1.2. Axes

Axes defined in FEM-Design are imported to Revit Project as grids. The exact length and geometry is transferred however, axes names are not imported. In Revit grids will be numbered accordingly with the order of their creation in FEM-Design, as shown in the example in Figure IV-2.

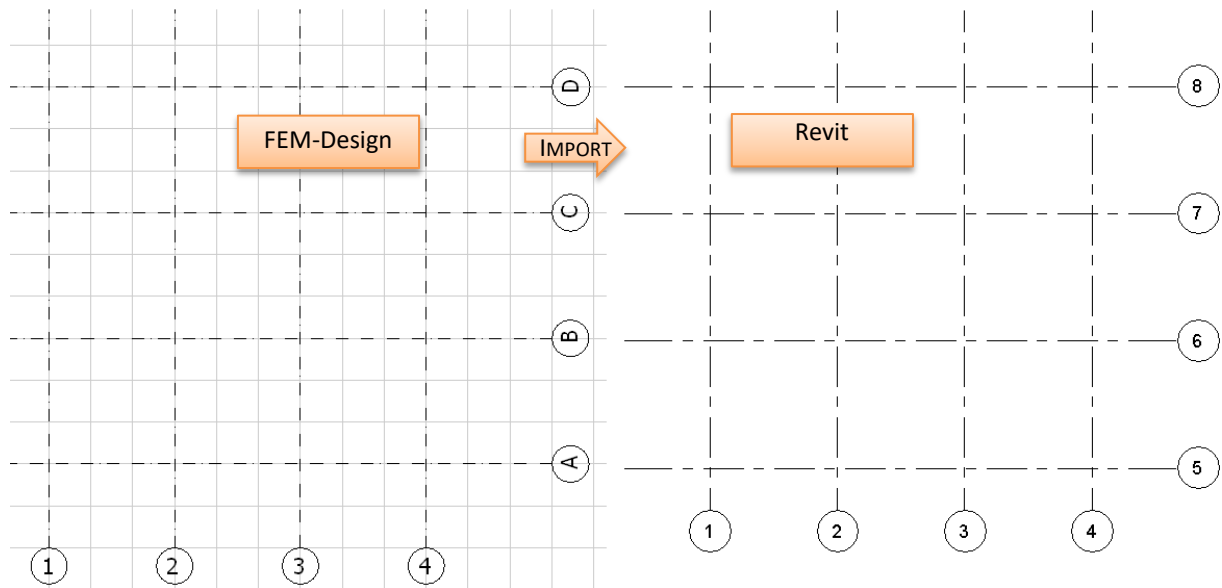

Figure IV-2

7.2. Bar elements

Every section and material of bar elements defined in FEM-Design has to be mapped into corresponding materials and family types in Revit project. Read more about the mapping process in Chapter 8.4.

7.2.1. Columns

A column element defined in FEM-Design is imported to Revit project as a *Structural Column* element. Along with the geometry of a column, following properties are transferred:

- *Rotation*
- *Releases*: assigned as *Start* and *End release* parameter of analytical column.
- *Structural Material*: mapping required.



Eccentricity of a column defined in FEM-Design cannot be transferred into Revit project. The default position of an analytical column, in relation to physical column, will always be *Center*.

7.2.2. Beams

A beam element defined in FEM-Design is imported to Revit project as a *Structural framing: Beam* element. Along with the geometry of a beam, following properties are transferred:

- *Rotation*: assigned as *Cross-section rotation* instance parameter of a physical beam.
- *Releases*: assigned as *Start* and *End release* parameter of analytical beam.
- *Structural Material*: mapping required.

- *Eccentricity*: assigned as *y Offset Value* and *z Offset value* instance parameter of a physical beam.

7.2.3. Truss elements

A truss element defined in FEM-Design is imported to Revit project as a *Structural framing: Brace* element. Along with the geometry of a truss element, following properties are transferred:

- *Rotation*: assigned as *Cross-section rotation* instance parameter of a physical beam.
- *Structural Material*: mapping required.



There is no possibility of defining *release conditions* of a truss element in FEM-Design therefore, imported braces will be assigned with the default Revit release conditions, i.e. user defined (start) / pinned (end). There are no eccentricity settings for a truss element in FEM-Design therefore, braces will be imported with the default position of the analytical model, which is center of element.

7.3. Shell elements

Each of the shell elements (plates and walls) has to be mapped separately into corresponding type of a floor or wall element in Revit. Read more about the mapping process in Chapter 8.4.

7.3.1. Plates

A plate element defined in FEM-Design is imported to Revit project as a *Floor: Structural*. Along with the geometry of a plate, following properties are transferred:

- *Structural Material*: as parameter of a floor type chosen at mapping.
- *Eccentricity*: one of the three alignment settings from FEM-Design is imported to FEM-Design as *z Projection* parameter of an analytical floor element, according to the following rule:
 - Top /Left alignment from FD --> *z Projection*: Top of Slab
 - Center alignment from FD --> *z Projection*: Center of Slab
 - Bottom/Right alignment from FD --> *z Projection*: Bottom of Slab



Be aware that a manual definition of an eccentricity value for a plate in FEM-Design (e[m]) cannot be imported along with the plate element.

7.3.2. Walls

A wall element defined in FEM-Design is imported to Revit project as *Wall: Structural*. Along with the geometry of a wall, following properties are transferred:

- *Structural Material*: as parameter of a floor type chosen at mapping.
- *Eccentricity*: alignment settings from FEM-Design are imported to FEM-Design as *z Projection* parameter of an analytical wall element, according to the following rule:
 - Left alignment from FD --> *z Projection*: Interior Face
 - Center alignment from FD --> *z Projection*: Center of element
 - Right alignment from FD --> *z Projection*: Exterior Face



Be aware that a curve wall in FEM-Design is modeled as a number of regular walls and this is also the way it will be imported to Revit.

7.4. Profiled panels

Profiled plate panels created in FEM-Design model can be saved to struxml as plate elements and imported to Revit as *Floor: Structural*. The same rules apply as in case of importing plate elements. Each group of profiled panels will be exported as one floor boundary.

7.5. Foundations

Each of the foundation elements has to be mapped separately into corresponding type of an isolated foundation, wall foundation or foundation slab. Read more about the mapping process in Chapter 8.4.

7.5.1. Isolated foundation

An isolated foundation element defined in FEM-Design is imported to Revit project as a *Structural foundation: Isolated* element. Along with the geometry of an isolated foundation element, following properties are transferred:

- *Structural Material*: mapping required.



Isolated foundation does not need a host element (e.g. column) to be imported to Revit.

7.5.2. Wall foundation

A wall foundation element defined in FEM-Design is imported to Revit project as a *Structural foundation: Wall* element. Along with the geometry of an isolated foundation element, following properties are transferred:

- *Structural Material*: mapping required.



Wall foundation requires a host element in Revit - Structural wall therefore, wall foundations do not attached to a wall element in FEM-Design will not be exported (warning will be thrown).

There are no properties of Wall foundation in Revit that would allow for setting the eccentricity therefore, eccentricity of wall foundation defined in FEM-Design will not be imported.

There is one recognized issue at the import of wall foundation. If wall foundations are added to a wall that contains a wall opening, after import of those elements to Revit, a wall foundation will also be added to the top edge of the opening, as shown in Figure IV-3. This issue will hopefully be solved in one of the next release of the StruSoft StruXML Revit Add-In.

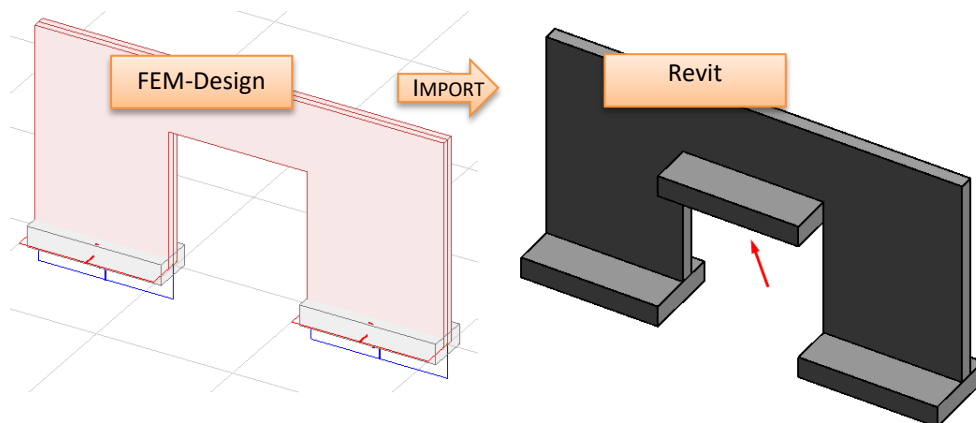

Figure IV-3

7.5.3. Foundation slab

A foundation slab element defined in FEM-Design is imported to Revit project as a *Structural foundation: Slab* element. Along with the geometry of a foundation slab element, following properties are transferred:

- *Structural Material*: as parameter of a floor type chosen at mapping.
- *Eccentricity*: alignment settings from FEM-Design are imported to FEM-Design as *z Projection* parameter of an analytical foundation slab element, according to the following rule:
 - Top /Left alignment from FD --> *z Projection*: Top of Element
 - Center alignment from FD --> *z Projection*: Center of Element



Be aware that a manual definition of an eccentricity value for a foundation slab in FEM-Design (e[m]) cannot be imported along with the foundation element.

7.6. Supports

Both the supports and supports group defined in FEM-Design can be imported to Revit project. The exact support definition is imported to Revit as *User* boundary condition. There are however, substantial differences between the elements type that supports can be added to between FEM-Design and Revit. Please find the details in below paragraphs.

7.6.1. Point support and point support group

Point support and point support group defined in FEM-Design are imported to Revit project as *Point Boundary Condition* of a *State: User*.



Point boundary condition in Revit requires a host element and can only be applied to an end of a beam, column or brace element. Therefore, if a point support (group) in FEM-Design is applied to a wall or plate element, or not to an edge of linear element, or is independent, a warning informing about the lack of reference element will be thrown at the import.

There is one recognized issue about the import of point support group. If a point support group is defined in a local coordinate system of an element that is different than the global coordinate system of the FEM-Design model, and the stiffness of this point support group is not the same in all directions, an error will be thrown and this support will not be imported.

7.6.2. Line support and line support group

Line support and line support group defined in FEM-Design are imported to Revit project as *Line Boundary Condition* of a *State: User*.



Line boundary condition in Revit requires a host element and can be applied to a beam, column, wall and floor element. Therefore, if a line support (group) in FEM-Design is applied to a brace, or is independent, a warning informing about the invalid reference will be thrown at the import.

7.6.3. Surface support group

Surface support group defined in FEM-Design are imported to Revit project as *Are Boundary Condition* of a *State: User*.



Area boundary condition in Revit requires a host element and can be applied to a wall or a floor element. Therefore, if a surface support group in FEM-Design is independent, a warning informing about the lack of reference element will be thrown at the import.

7.7. Loads and load cases

Following loads types defined in FEM-design can be imported to Revit:

- Point load
- Line load
- Surface load

Load cases defined in FEM-Design can be imported to Revit project under condition that there is at least one load applied to the structure.

The load cases imported from FEM-Design will be added to the existing load cases in Revit (if any). Type and the duration class parameters are not imported to Revit; all the imported load cases will be assigned with the Dead Nature and Dead loads Category. Figure IV-4 and Figure IV-5 shows an example of the imported load cases.

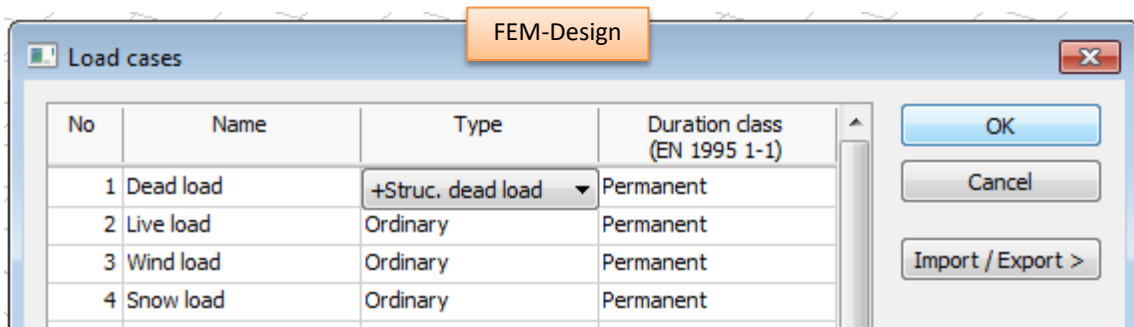

Figure IV-4

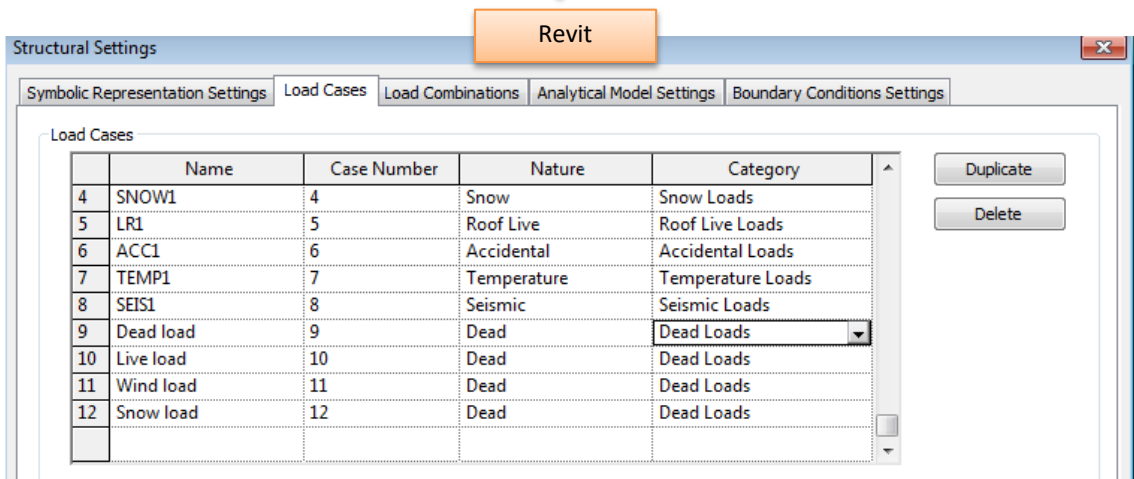

Figure IV-5



If a name of the load cases imported from FEM-Design is the same as name of the existing load case in FEM-Design, import will not be possible and an error message will be thrown.

8. Import FEM-Design model to Revit

8.1. Requirements:

There has to be at least one level defined in the Revit project into which a FEM-Design model will be imported, or at least one storey has to be included in the imported FEM-Design model. It is required because elements in Revit have to be placed on a level or with a certain reference to a level.

All the frame sections and materials, wall and floor types and foundation element types that are equivalent to the elements and materials existing in the FEM-Design model, has to be included in the Revit project, or proper families and types should be created there prior to mapping. Read more about it in the Chapter 8.4. In one of the next releases of StruXML StruSoft Revit Add-In this will be improved and user will have a chance to create materials and element types from the level of mapping dialog.

8.2. Export FEM-Design model to struxml file

The first step is to export the FEM-Design model into a file. This is done by saving it as a *.struxml file type. In FEM-Design go to *File* → *Save as* → type a name in the *File name* field → chose *.struxml in the *Save as type* field → *Save*.

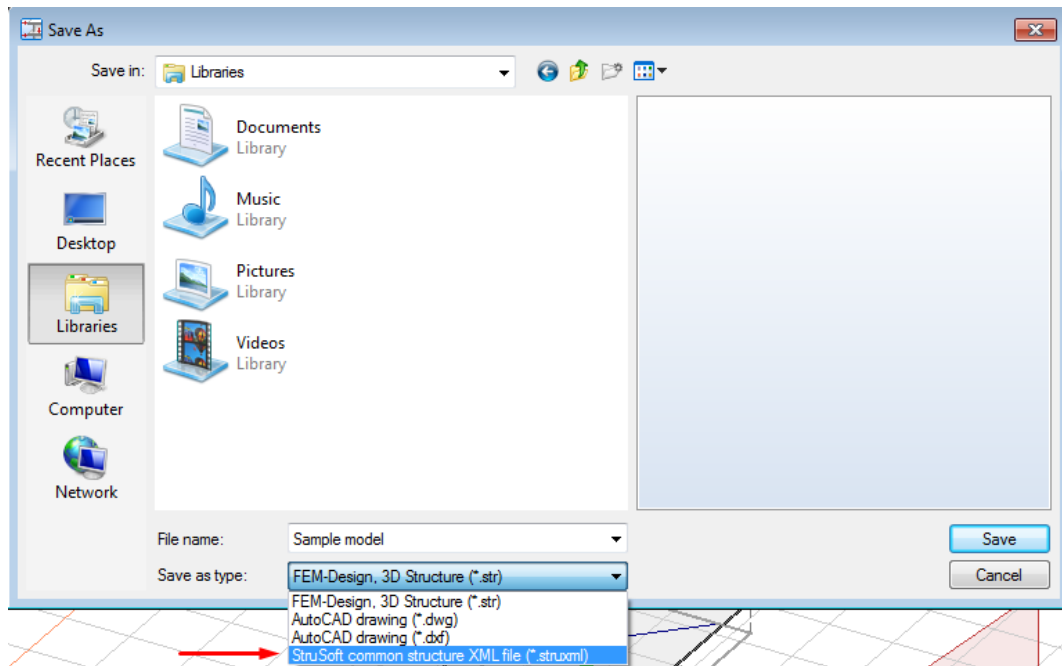

Figure IV-6

8.3. Import struxml file to Revit

Go to *Analyze* tab and find *Import StruXML* command in the *StruSoft FEM-Design* panel (Figure IV-7). This is the only command that one has to use in order to import a FEM-Design model to Revit.

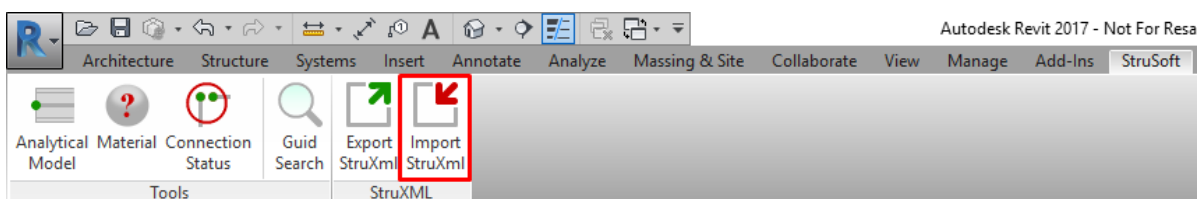

Figure IV-7

Upon pressing the *Import StruXML* command, an *Import StruXML* dialog will pop out, as shown in Figure IV-8.

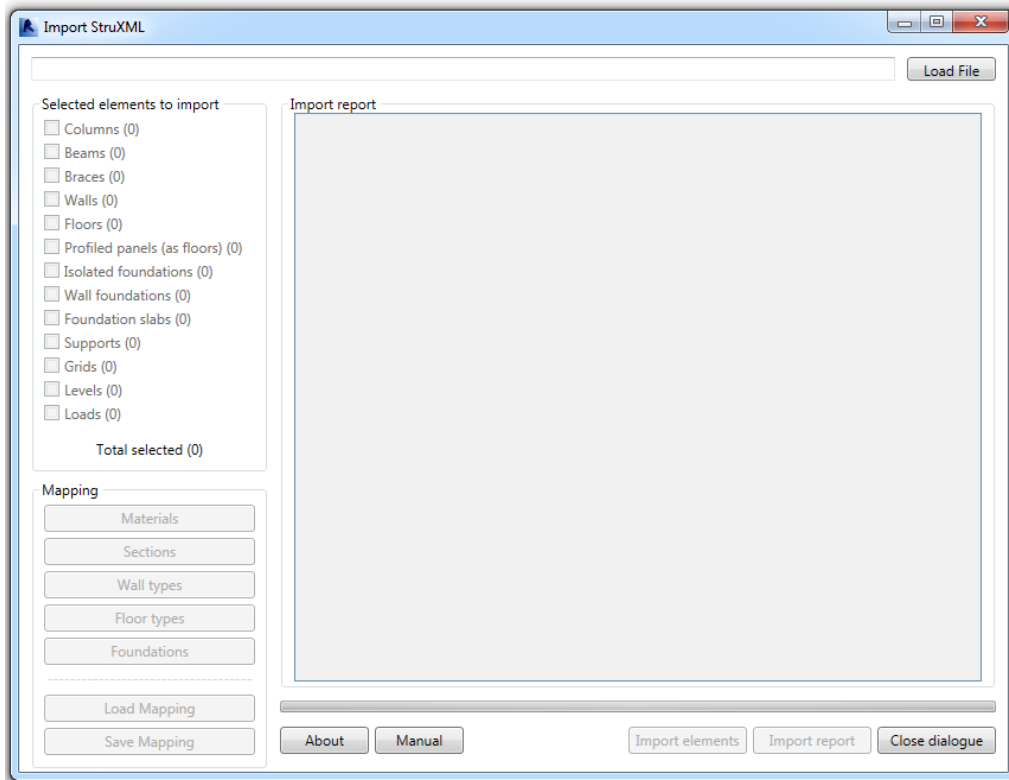
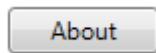
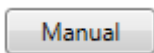

Figure IV-8

At first only *Load file*, *About*, *Manual* and *Close dialogue* buttons are active:



Use this button in order to check the version of the StruSoft StruXML Revit Add-In installed.



Use this button in order to download the latest version of StruSoft StruXML Revit Add-In User Manual.

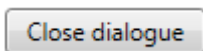

Use this button in order to close the *Import StruXML* window.

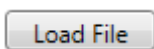

Use this button in order to load the struxml file to be imported.

Upon loading a struxml file, *Selected elements to import* and *Mapping* panels will become active.

Selected elements to import panel contains a list of all possible element categories that can be imported to Revit. Only the categories that are present in the struxml file will become active (for instance if there are no grids and levels in the imported model, those categories will remain inactive; check Figure IV-9).

In the *Selected elements to import* panel user has a chance to see how many elements of a given category are present in the file and how many elements in total will be imported. One has also a chance to unselect a certain category that is present in the struxml file so it will not be imported to Revit project (check Figure IV-9).

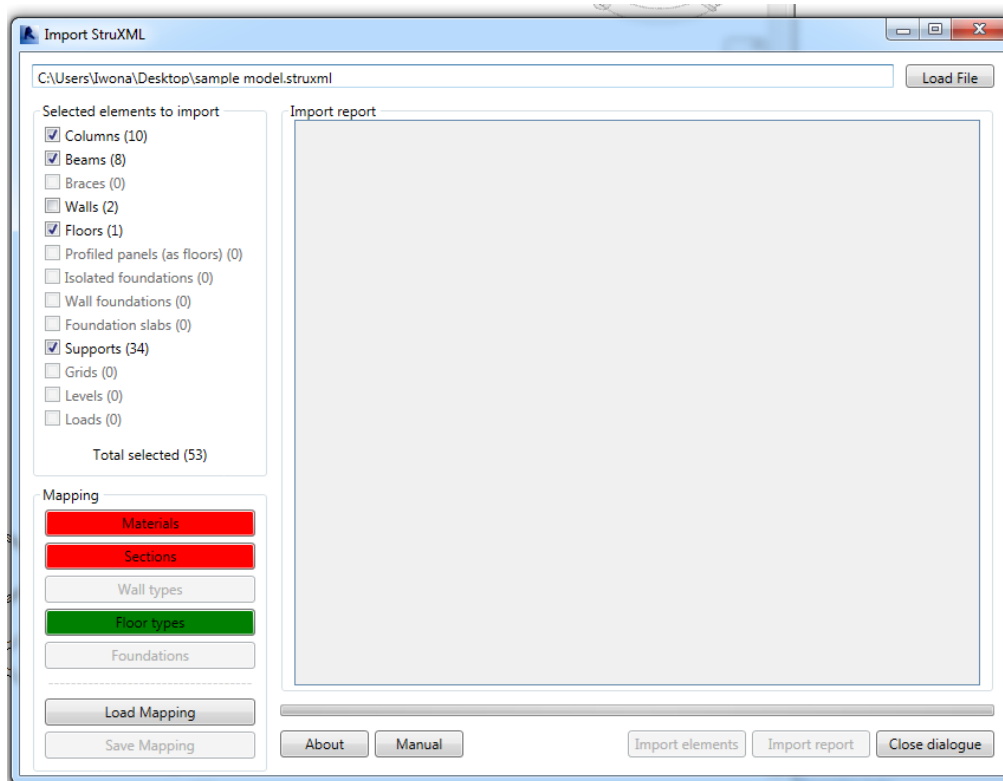

Figure IV-9

In the *Mapping* panel, one should map all elements that are about to be imported into Revit project.

Mapping panel contains five mapping buttons that correspond to different kind of element types. Again, only mapping categories for elements that are present in the struxml file, and were selected to be imported in the *Selected elements to import* panel, will be active.

If all elements within one category are mapped, the button will turn green. Otherwise it will remain red, until mapping is completed. Read more about the mapping procedure in the Chapter 8.4.

Once done mapping can be saved to struxml, and loaded next time to be used with another model.

When the mapping procedure is finished, *Import elements* button will become active. It will only become active if all the elements (and materials) were mapped.

Upon pressing *Import elements* button, selected elements will be imported to the Revit project and an *Import report* dialog will become active. There, one can see a list of possible warnings, errors and total amount of elements imported to Revit (check Figure IV-10). Press *Import report* button, to see a complete overview of all imported elements.

Import procedure

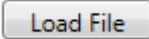
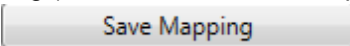
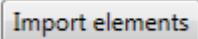
1. Click on  and chose a struxml file to be imported.
2. In the *Selected elements to import* panel, decide which elements to export (among those that are present in the struxml file).
3. Perform the mapping (read more about the mapping procedure in the Chapter 8.4.)
4. Optionally: press  in order to save mapping into struxml.
5. Press  in order to import the selected elements into Revit project.

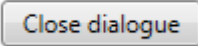
6. Optionally: press  to see an overview of all imported elements.
7. Press  in order to close the Import StruXML window.

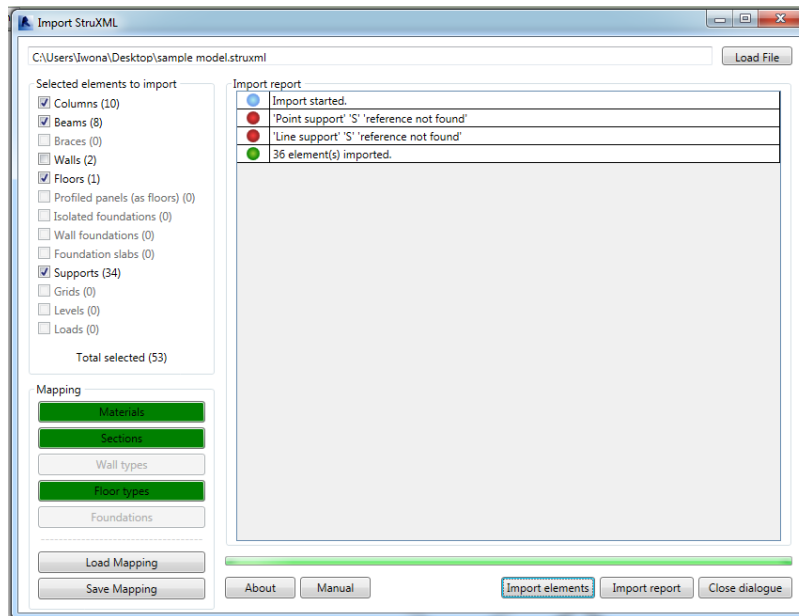

Figure IV-10



Import procedure may take up to several minutes in case of large models with many elements. Observe the green line to see the progress of the import (available only in Revit 2014).

8.4. Mapping

Mapping panel is divided into five different mapping buttons:

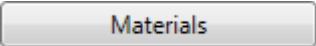
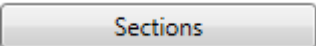
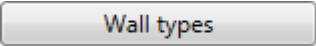
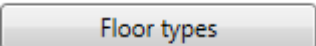
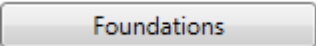
- | | |
|-------------------------------------------------------------------------------------|---------------------------------------------------------------------------------------------------------------------------------------------------------------------------------------------------------------------------------------------|
|  | Here materials for standard component families: columns, beams, braces, isolated foundations should be mapped. Mapped material will be assigned to a <i>Structural material</i> parameter under condition that it is an Instance parameter. |
|  | Here sections for standard component families: columns, beams, braces) should be mapped. |
|  | Here wall types should be mapped. Remember that material of a wall is a Type parameter and is included in Wall type. |
|  | Here floor types and profiled panels should be mapped. Remember that material of a floor is a Type parameter and is included in Floor type. |
|  | Here all kind of foundations (isolated, wall and foundation slab) should be mapped. Remember that material of a wall foundation and foundation slab is a Type parameter and is included in wall foundation and foundation slab type. |

Every mapping dialog consists of two columns:

- on the left hand side there is a column where all FEM-Design materials / sections / wall types / etc. used in the imported model are listed,
- on the right hand side there is a column where corresponding Revit material / section / wall type / etc. should be loaded. The Revit library appears upon clicking on the white field in a certain row.

Be aware that the material / sections / wall and floor types / foundations libraries only contain materials / sections / wall types / etc. that existed, or have been loaded or created in the Revit project prior to importing the struxml file.



If a certain material / section / wall type / etc. is missing during the mapping process, one has to terminate the import process and create this certain material / section / wall type / etc. in the Revit project first. An option to create a new material / section / wall type / etc. from “inside” the Add-In will be implemented in one of the next releases of StruXML StruSoft Revit Add-In.

If you see the same material, section (of column, beam, truss, etc.) or type (of slab, wall, etc.) listed more than one time in the mapping dialog, it means that there are more elements that have the same materials, section or type, but they have different properties and therefore, have to be mapped separately.

8.4.1. Materials mapping

Upon pressing *Materials* button, *Materials mapping* dialog will pop out. Here, in the left column (*FD Materials*) one can see a list of all the materials that were assigned to columns, beams, truss members and isolated foundations in the FEM-Design model.

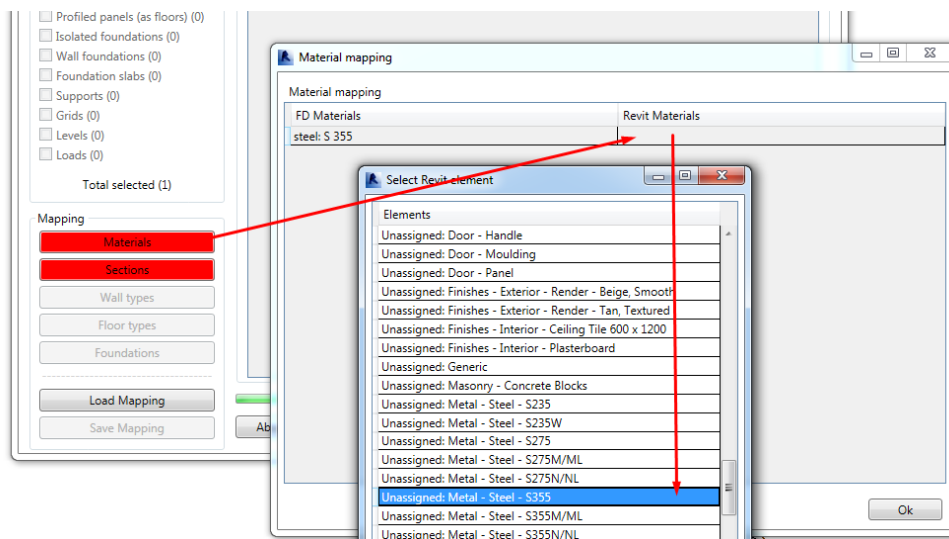

Figure IV-11

In order to map a selected material into a corresponding material from the Revit library, one has to click on the white field in the right hand side column (*Revit materials*). A *Select Revit element* dialog will pop out. It contains all materials from the Revit project material library that one can browse to find a matching material. Double click to select a material.

Example is shown in Figure IV-11.

It is also possible to perform multiple mapping, i.e. select the same material / section / type / etc. to a several elements imported from FEM-Design. Select several elements in the mapping dialog (with Ctrl button), right click and chose *Assign all selected*, as shown in Figure IV-12

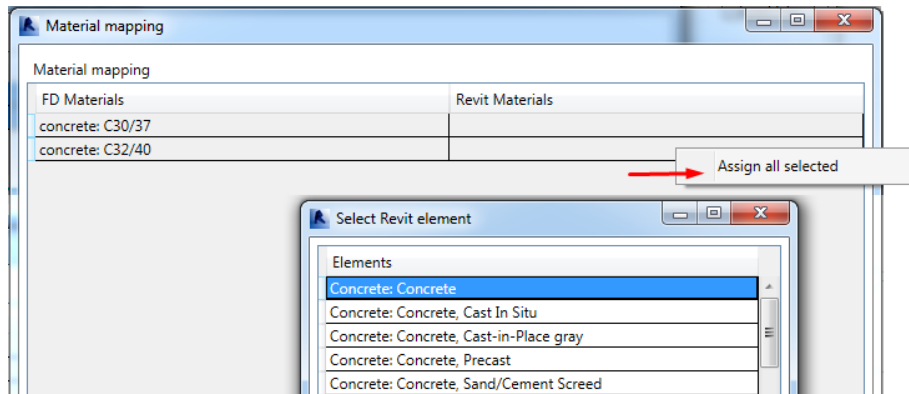

Figure IV-12

8.4.2. Sections mapping

Upon pressing *Sections* button, *Sections mapping* dialog will pop out. Dialog is divided into two parts: *Beam mapping*, where beams and braces should be mapped and *Column mapping*, where columns should be mapped.

In the left column (*FD Materials*) one can see a list of all sections used FEM-Design model. In order to map a selected section into a corresponding section from the Revit library, one has to click on the white field in the right hand side column (*Revit Sections*). A *Select Revit element* dialog will pop out. It contains all the beam (or column) sections included in the Revit project that one can browse to find a matching section.

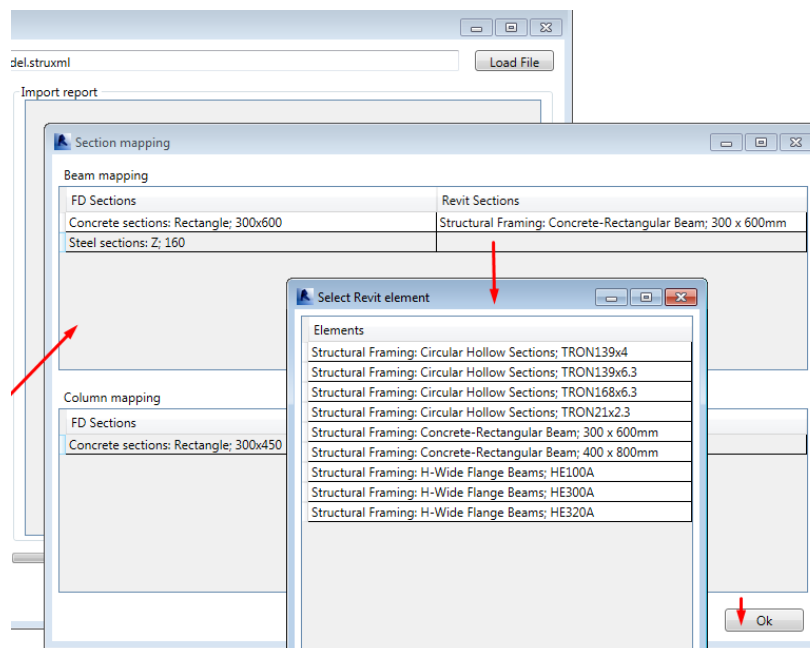

Figure IV-13

8.4.3. Wall types mapping

Upon pressing *Wall types* button, *Wall types mapping* dialog will pop out.

In the left column (*FD Types*) one can see a list of all wall types used FEM-Design model. In order to map a selected wall into a corresponding wall type from the Revit library, one has to click on the white field in the right hand side column (*Revit Types*). A *Select Revit element* dialog will pop out. It contains all the wall types included in the Revit project that one can browse to find a matching one.

Example is shown in Figure IV-14.

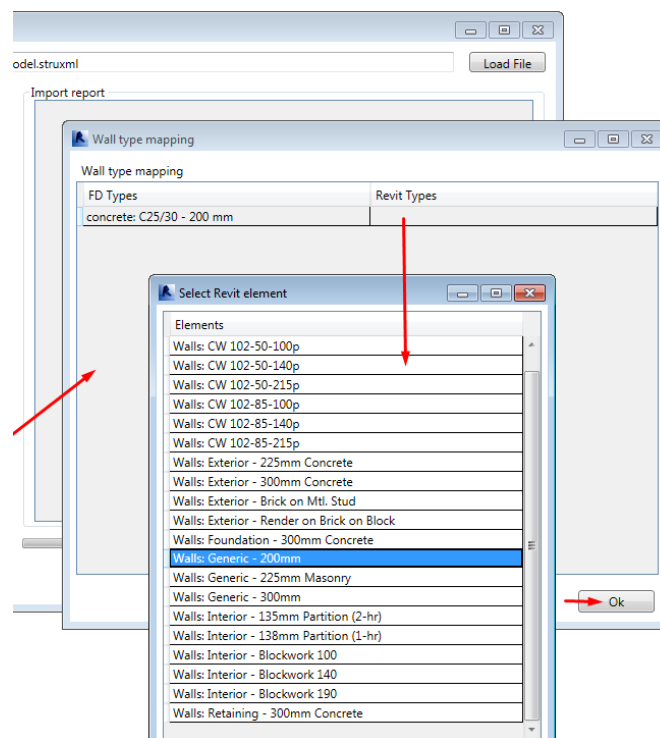

Figure IV-14



Structural Material property of a wall is a type parameter that is included in the wall type that one has to choose in the mapping process. Therefore, make sure that a wall type that you chose from the Revit library has a proper material assigned.

An example can be the *concrete C25/30 – 200 mm* wall that was created in FEM-and was mapped into *Wall: Generic – 200mm* (Figure IV-14). This particular wall has a certain material assigned to it, what can be seen when checking its type properties (Figure IV-15).

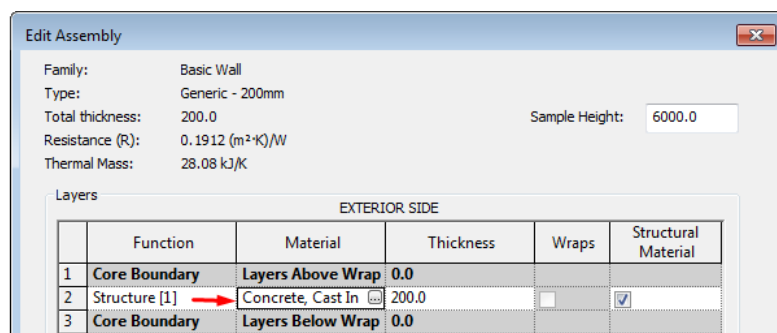

Figure IV-15

8.4.4. Floor types mapping

Floor types mapping is equivalent to the Wall types mapping procedure. In this dialog profiled panels can also be mapped into corresponding floor types.



Structural Material property of a floor is a type parameter that is included in the floor type that one has to choose in the mapping process. Therefore, make sure that a floor type that you chose from the Revit library has a proper material assigned.

8.4.5. Foundations mapping

Upon pressing *Foundations* button, *Foundation mapping* dialog will pop out. Dialog is divided into three parts: *Isolated foundations mapping*, *Wall foundation mapping*, and *Foundations slab mapping*.



Structural Material property of a *Wall foundation* and *Foundation slab* is a type parameter that is included in the wall foundation and foundation slab type that one has to choose in the mapping process. Therefore, make sure that a floor type that you chose from the Revit library has a proper material assigned.

8.5. Warnings and errors

There is couple of situations in which import of certain elements will not be possible, and a warning or error message will be thrown in the *Import report* dialog:

Most of the error occurs because of the different approach to certain situation between Revit and FEM-Design. Most of those situations are related to supporting structures and their hosts. Revit simply do not allow for situations that are allowed in FEM-Design, for example to attach a point support to a wall or floor element. Below, all recognized situations are listed:

1. if a support (point support, line support, and surface support) in FEM-Design is attached to an element that is not allowed by Revit, or is not attached to any element, an error message will be thrown in a format:
"Point support / Line support / Surface support", "support name and ID from FEM-Design", "reference not found"
2. The next situation when an error will be thrown, is an import of a wall foundation without a host wall, or attached to other element than a wall – situation like this is not possible in Revit and wall foundation can only be attached to a wall element. An error message will be thrown in a format:
"Wall foundation", "wall foundation name and ID from FEM-Design", "wall not found"
3. Sometimes, an opening in a wall cannot be recreated while importing the wall into Revit and an error message will be thrown in a format:
"Wall", "wall's name and ID from FEM-Design", "Revit function failed to create an opening for a certain wall"

In case of a problematic situation that was not expected while implementing the StruSoft StruXML Revit Add-In, an *"unexpected error"* message may appear. In this situation, please contact the support team.